

Dew Point Mirror 373



OPERATION AND MAINTENANCE MANUAL

Warranty

MBW Calibration Ltd. (MBW) warrants the products it manufactures or distributes to be free of defects in material and workmanship under normal use and service when operated within the specified design limitations for a period of 12 months from date of initial shipment. Under this Warranty, MBW will, at its discretion, repair or replace any component that upon examination by MBW or its duly authorized representatives proves to be defective during the warranty period provided the system is returned to the factory for inspection and repair shipping prepaid. Improper or unauthorized maintenance, storage, repair, or alteration of any kind by personnel other than MBW or its duly authorized representatives may void all warranties. Warranty may also be voided for misuse, neglect, accident, corrosion, and improper installation. This Warranty is exclusive and in lieu of any and all other warranties of merchantability, fitness for a particular purpose, or any other warranty, expressed or implied, and all other liabilities and obligations on the part of MBW. MBW will not be liable for any other claims or damages, either direct, indirect, or consequential arising out of the use of its products.

Original manuals are prepared in English and German. Translations in other languages are available, but in the event of any discrepancy, the German or English versions will be considered as the official version.

Subject to change without notice.

For the latest version of this manual please visit our website.

Copyright © 2014

2014-02-20

MBW Calibration AG

Seminarstrasse 55/57

CH-5430 Wettingen / Switzerland

+41 56 437 28 30 phone

+41 56 437 28 40 fax

sales@mbw.ch

www.mbw.ch

Table of Contents

WARRANTY	I
Table of Contents	iii
Welcome	1
How to Use This Manual	1
For More Information	1
OPERATION	3
Getting Started	3
Turning the 373 On and Off.....	3
What You See	3
The Touch Screen	5
The Measuring Head Assembly	7
Dew Point Measurement.....	7
System Configuration	12
Menu Options	12
Display Parameters.....	13
Graphing Data	13
Control Setup.....	15
Changing Units	18
Changing Color.....	20
Analog Outputs.....	21
Back Panel Connections	23
Power Plug	23
Power Switch.....	23
RS-232	23
External Temperature	23
Mirror Temperature.....	24
Analog Outputs.....	24
Gas Input and Output.....	25
Hose Heaters.....	25
Barometric Pressure Input.....	25
Cooling Water.....	25
Measurement Tips	26
Determine the Measuring Range.....	26
Connecting Hoses.....	27
Cooling Requirements.....	29
Heating Requirements	29
INSTALLATION	31
Facility Requirements	31
Environmental.....	31
Power	31
Cooling Water.....	31

Preparation for Use	31
Benchtop Use	31
Rack Mounting.....	32
Preparation for Shipping or Transportation	32
REMOTE COMMUNICATION	33
Introduction	33
Hardware Connection & Cabling	33
Communications Settings	33
Command Syntax	34
General Usage.....	34
Termination Characters.....	34
Leading and Trailing Spaces.....	35
Case Sensitivity	35
Numeric Values	35
Command Reference	36
Commands Listed By Functional Group	37
MAINTENANCE	43
Mirror Cleaning	43
Exterior Cleaning	44
Front Panel.....	44
Rear Fan Grills.....	44
DRAWINGS	45

Welcome

Congratulations! With the 373 Dew Point Mirror you will be able to perform precision dew point and frost point measurements as well as measurements of other parameters such as relative humidity. The 373 utilizes a full color active matrix liquid crystal display with an integral touch panel. It has a high contrast ratio and a wide viewing angle for easy readability. Data is displayed in large easy to read fonts. Using the on screen buttons and menus, you can easily configure each line of the display for a variety of humidity, temperature, and pressure parameters that may be viewed in either SI or non-SI units.

How to Use This Manual

If you have the time and inclination, you can read this manual from front to back. Since we realize your time is valuable and you may not wish to do that yet, we recommend the following approach to familiarize yourself with the 373 and start using it right away.

1. With the 373 at hand, go straight to the Getting Started section on page 3. From there, you can quickly learn to use the 373 to make a dew point measurement.
2. Next, read the System Configuration section beginning on page 12 to learn how to configure the system to meet your preferences.
3. Finally, read the Back Panel Connections section beginning on page 23. That section identifies all the electrical, fluid, and gas connections available on the back panel and explains how and when to use them.

For More Information

For a more thorough understanding of the 373 and other humidity measurement information, please read the remaining sections of this manual.

The Installation section tells you how to mount the system into a 19-inch rack, and what supplemental parts will be needed to do so. It also covers environmental and power requirements, and in some applications the requirement for cooling water.

The Remote Communication section discusses the RS-232 interface both from a hardware and software perspective. It gives details relating to cabling to connect the 373 to a computer, and gives the syntax and examples of each of the commands that the 373 recognizes.

The Maintenance section covers topics such as Mirror Cleaning and general maintenance required to keep your 373 performance at its best.

If the information you seek is not in one of the manual's included sections, never hesitate to contact us with your questions. Relevant phone, fax, and email contact information is on the front page of this manual.

Operation

Getting Started

This section allows you to set up and start using the 373 right away. You'll turn the system on and quickly familiarize yourself with the layout and features of the display and touch screen. Next, you'll learn about the optical mirror assembly for later care and cleaning that may be required. Finally, you'll use the 373 to measure the dew point temperature. Set your 373 on the bench and let's get started!

Turning the 373 On and Off

The 373 needs a source of normal AC power. Have a look at the label on the back panel of the instrument for the voltage required. Chances are, the required voltage matches that of your standard laboratory power receptacles.

1. Using the supplied AC power cord, supply the proper voltage to the instrument by plugging the cord into the back of the instrument, then into an AC receptacle of the proper voltage.
2. The power switch is located on the back panel next to the power cord input. Turn it ON.

The display should become visible within a few seconds. If nothing seems to happen, check the power source. There may also be some fuses located next to the power switch. You can remove and replace them with known good ones. Suspect fuses can be tested for continuity with an ohmmeter.

What You See

When power is applied to the 373, the display will activate within a few seconds. A typical display configuration is depicted below. If you or someone else previously configured your system, it may look slightly different. But don't worry, we'll show you how to set it up the way you like.

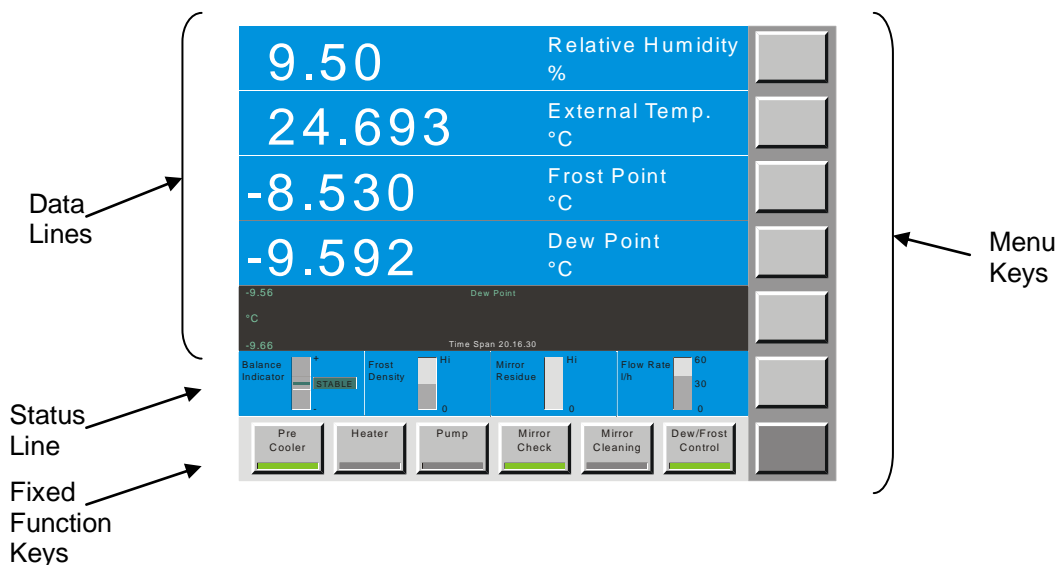

Data Lines

The first five lines of the display are for numeric or graphic representation of the measured data. We refer to those first five lines as *data lines*.



If numeric, a data line contains the value to the left, with the parameter description and units to the right.

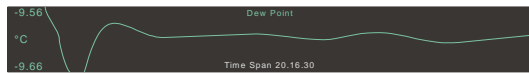

If graphic, a data line shows a simple graph of the data over time.

The choice of which parameter is shown on which data line, as well as whether a data line is viewed as numeric or graphic, is easily selectable. You'll see how to make these selections shortly.

Status Line



Near the bottom of the display is the *status line*. The status line contains balance, density, contamination, and flow rate indicators. The position and configuration of the status line never changes.

Fixed Function Keys



The bottom line of the display contains a row of fixed function keys. You'll use these keys to start and stop the pump, enable and disable measurement of dew point, and other things. The function of each of these keys never changes, and they are always available for use.

Menu Keys



Use this key to change menus

To the right side of the display is a column of menu keys. Each of these keys changes function as needed.

Notice that the bottom key in this column is different from the rest. The bottom key is used to cycle the upper keys through the various menu options. The text on the bottom key changes to indicate the currently selected menu option. The text of the upper keys change based on the functions available in the menu.

The Touch Screen

The 373 utilizes a touch screen for user interaction. To activate a menu option or toggle a function on or off, simply touch the screen directly over the key or object desired.

Calibrate the Touch Screen

Before using the 373 for the first time, you may need to calibrate the touch screen to your finger positioning preference. Here's how –



1. Press and hold the *enter* key on the numeric keypad for 3 or 4 seconds. If you've done it correctly, you'll hear two loud short beeps. If not, release the key and try again.



2. With the tip of your finger, press the center of the yellow key in the upper right corner of the touch screen. It is labeled 'Touch This Key'. Once you touch it, the yellow color goes away and another key turns yellow.
3. Now, touch the yellow key that's in the lower left corner of the touch screen. Once you touch it, the yellow color goes away and you have successfully calibrated the touch screen.
4. Test your new touch screen calibration by pressing each of the six blank menu keys on the right side of the touch screen several times. If they seem not to work well, just

repeat the calibration steps again from the beginning.

You may recalibrate the touch screen as often as needed, however, it is rarely required.

Navigating the Menus

The various menus of the right column of keys are navigated by using the key in the lower right corner of the touch screen. Each time you press the lower right key, a new menu appears on the keys directly above it. The menu is circular, meaning that once you go past the last menu, the first one appears again and the process starts over. You can use the +/- key on the keypad to move backward through the menus. Use the *enter* key to clear the menu.

Selecting Parameters to Display

Selecting which parameters to display on the five data lines is easy. It is done with the Parameter menu.

1. Use the lower right menu key to select the Parameter menu. 'Parameter' appears on the key, and the keys above get left pointing arrows. Notice that each key corresponds to the data line it points toward.
2. Press the arrow key corresponding to the data line you wish to change. Notice that each time you press the arrow key, the parameter of the data line changes. The parameter selection is circular, meaning that once you reach beyond the last available parameter the first one is again displayed and the cycle starts over.
3. Change the parameters on any of the other five data lines with the same method.
4. If you like, you may clear the menu keys when finished by cycling through all the menus using the lower right key on the touch screen, or by pressing the *enter* key once. Note that this is not required and nothing is wrong with leaving the Parameter menu (or any other menu) on the screen.

Selecting Graph vs. Numeric Data

Any data line may be viewed either as numeric or as a graph. The Numeric/Graphic menu is used to toggle any data line between numeric and graph mode.

1. Use the lower right menu key to select the Numeric/Graphic menu. 'Numeric/Graphic' appears on the key, and the keys above contain left pointing arrows. Notice that each key corresponds to the data line it points toward.
2. Press the arrow key corresponding to the data line you wish to change. Notice that the data line toggles between numeric or graph mode each time you press the key.
3. Select numeric or graph mode on any of the other data lines with the same method.
4. If you like, you may clear the menu keys when finished by cycling through all the menus using the lower right key on the touch screen, or by pressing the *enter* key once. Note that this is not required and nothing is wrong with leaving the Numeric/Graphic menu (or any other menu) on the screen.

Selecting Units

The data may be viewed in any of the many available units. There are two Units menus used to change the units of displayed data.

1. Use the lower right menu key to select the Units menu. 'Units' appears on the key, and the keys above contain current units indications such as 'Temp °C'. Notice that each of the keys contain different types of units. In this case, the keys do not correspond to the adjacent data lines, but rather to different units types.
2. To change temperature units, press the key labeled 'Temp'. Notice that the corresponding units change each time the key is pressed. Also notice that any data line that is currently indicating temperature data also changes to reflect the newly selected units.
3. Change other units (such as pressure, flow rate, etc.) with the same method.
4. Note that there are two Units menus since there are so many types of units that may be changed. The second Units menu is obtained by pressing the lower right menu key again.
5. If you like, you may clear the Units keys when finished by cycling through all the menus using the lower right key on the touch screen, or by pressing the *enter* key once. Note that

this is not required and nothing is wrong with leaving the Units menu (or any other menu) on the screen.

The Measuring Head Assembly



The heart of the 373 Dew Point Mirror instrument is the measuring head assembly. It is designed to be highly sensitive and accurate, yet rugged and easily accessible for periodic mirror cleaning. Although not required prior to initial operation, you may wish to familiarize yourself with the location and accessibility of the mirror and the other optical components within this assembly.

For further discussion of the measuring head, and the mirror cleaning procedure, refer to Mirror Cleaning on page 43.

Dew Point Measurement

When you power the 373 on, it begins in an idle state. In this state, it measures and displays temperature, pressure, and flow transducers, but does not yet provide any meaningful humidity related data. In order to provide humidity data (dew point, frost point, %RH, etc.), the Dew/Frost Control mode must be enabled and gas must be flowing across the mirror. If %RH is desired, note also that an external temperature probe must be connected. For external temperature probe use, see External Temperature on page 23.

Starting / Stopping the Pump

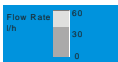

Some gas flow is required over the mirror when measuring the dew or frost point temperature. The nominal gas flow desired is approximately 20 to 60 liters/hour (0.2 to 1.0 liters/minute). If your 373 is equipped with an internal gas pump, you can use it to provide the necessary gas flow. If not, then you may need to provide for gas flow in some manner.



Use the Pump key on the bottom row of the touch screen to toggle the pump on/off. The Flow Rate indicator on the status line should indicate that gas is flowing. The actual rate of flow is not critical, but is best when within the limits previously mentioned. The gas flow may be adjusted with an external valve, or by changing the pump control parameters. See Pump Control on page 17.

Notes:

1. On the L and LX models, the gas inlet and outlet connections are generally capped for transportation, or during periods of non-use, in order to keep the gas path dry. You'll need to remove these caps to allow for gas flow.
2. The L and LX models are generally not equipped with a gas pump and therefore some alternate means of providing gas flow will be required for normal measurements. (Although the measurements will most likely be inaccurate, operating without flow does not harm the system. Therefore, you may continue on in this section even if your system is not equipped with a pump.)

Measuring the Room Ambient Dew Point Temperature



Lets use the 373 to measure the dew point temperature of the room by enabling the portion of the system responsible for cooling and maintaining the mirror at the dew or frost point temperature. Do so by pressing the Dew/Frost Control key. When enabled, a green bar on the key illuminates and any dew or frost point temperature indication begins to drop as the mirror cools toward the Point, see Selecting Parameters to Display on page 6 to select one of those parameters for display.

The Status Line

When the Dew/Frost Control is enabled, have a look at the Status Line. The Status Line is near the bottom of the display and has visual bar graphs that represent Balance, Density, Mirror Residue, and Flow Rate.

The Balance Indicator

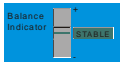

Although it is directly obtained from the intensity of the mirror's reflected light signal, the Balance Indicator is effectively the first derivative of the dew thickness. In other words, it indicates the rate of growth or decay of the condensed layer on the mirror. While the dew or frost layer is growing in thickness due to an increase in condensation on the mirror surface, the indicator is above center. The faster the layer grows the higher the indication. Conversely, if the layer is evaporating from the mirror surface thereby becoming thinner, the indicator is below center. The faster it decays the lower the indication. When the indicator is in the center, it indicates that the thickness of the dew or frost layer is neither growing nor decaying and that the layer on the mirror surface is in equilibrium with the gas. In this center-balanced indication, there is no net exchange of water vapor between the gas and the mirror surface. If the humidity of the gas sample is homogeneous and of low enough variability for the control system to sense a steady value, the Balance Indicator will illuminate a green 'Stable' message, and the system will emit a few short audible beeps.

The Density Indicator

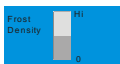

The Density Indicator graphically depicts the approximate relative thickness of the dew or frost layer currently on the mirror surface. Since the 373 has the ability to differentiate between dew and frost layers, it will also indicate which state the mirror's layer is in. The label within the density indicator will change from Layer Density (when it the state of the layer is uncertain) to either Dew Density or Frost Density (when either dew or frost is assumed). For more information regarding Dew/Frost point determination see Dew / Frost Control on page 15.



To disable the control system, press the Dew/Frost Control key again. The green bar on the key disappears indicating that the control is no longer enabled. Any dew or frost point temperature indications will begin to rise toward the temperature of the measuring head, often within several degrees of the ambient room temperature. Also, the density indication drops off and the balance indication moves downward but eventually returns toward center.

Note:

The L and LX models are equipped with an internal refrigeration system (precooler) that must be set and enabled for normal use. For the short duration test as described above, intended to last for only a minute or two, the precooler was ignored. However, use of the precooler is normally required for dew/frost point measurements. Please ensure that you have familiarized yourself with the proper use of the precooler. See Pre-Cooler (Refrigerated Cooling on page 18).

Gas Inlet Connection

While the previous example did not rely on any external gas connections, the 373 is equipped with fittings for connection of gas inlet and outlet tubing. This allows the 373 to measure the dew or frost point of chambers and other devices that can be connected to it via tubing. If you have a gas source you wish to measure, such as a humidity generator or chamber, connect a tube between it and the 373 gas inlet on the back of the unit.



The input and output connectors are clearly labeled on the Sample Gas section of the back panel. Depending on the specific model and ordered options, the stainless steel gas input and output connections may be 6 mm Swagelok, ¼ inch Swagelok, or ¼ inch Cajon VCR.

Note that unless your system is properly equipped to do so, you should never attempt to measure any gas with a dew point temperature that is at or above the temperature of the room. If you do, condensation will form inside the tubing. For these high dew point measurements, heated internal components and heated hoses are required. If your 373 is so equipped, there are electrical connections near the gas input and output connectors for control of the hose heaters.

For further information on use of the 373 with heated hoses, see Heater Controls on page 17, and Heating Requirements on page 29.

Range Limitations

Each 373 has a specific range of operation. To cover the entire range of -95°C frost point to $+95^{\circ}\text{C}$ dew point requires two or more separate instruments with some limited amount of overlap between them. While your instrument may be slightly different, the information discussed in the section titled Determine the Measuring Range on page 26 should give some guidelines as to the useable working range of your instrument. The specific measuring range of your instrument should be indicated on the back panel label.

Swagelok® Tube Fittings

Swagelok® brand tube fittings are generally used to connect the gas inlet and outlet tubes to the 373S, H, and HX systems. Depending on the configuration of your specific 373, the back panel fittings are either 1/4" or 6 mm. When ordering tube fittings from your local Swagelok® supplier, be sure to specify the correct size for your instrument. Swagelok® tube fittings come to you completely assembled, finger-tight and ready for immediate use. Disassembly before use is unnecessary and can result in dirt or foreign material getting into fitting and causing leaks.

SWAGelok® Tube Fittings are installed in three (3) easy steps:



Simply insert the tubing into the SWAGelok® Tube Fitting. **Make sure that the tubing rests firmly on the shoulder of the fitting and that the nut is finger-tight.**



Before tightening the SWAGelok® nut, scribe the nut at the 6 o'clock position.



Hold the fitting body steady with a backup wrench and tighten the nut 1-1/4 turns.① Watch the scribe mark, make one complete revolution and continue to the 9 o'clock position.

By scribing the nut at the 6 o'clock position as it appears to you, there will be no doubt as to the starting position. When the nut is tightened 1-1/4 turns to the 9 o'clock position, you can easily see that the fitting has been properly tightened.

Use of a Swagelok® Gap Inspection Gage (1-1/4 turns from finger-tight) ensures sufficient pull-up.

① For 1/16", 1/8", 2 mm, 3 mm and 4 mm size tube fittings, only 1/4 turn from finger-tight is necessary.

Cajon® Tube Fittings

All low range systems, Models 373L and LX, are generally equipped with Cajon® VCR Face Seal fittings that provide a true metal-to-metal seal. Mating Cajon® VCR fittings may be obtained from your local Swagelok® supplier.

Handling

A protective cap is placed on all VCR sealing beads to prevent nicks or scratches. Damage to the sealing beads will affect the fitting performance and cause system leakage. This cap should remain in place during storage and handling.

Note: Standard bead protection for VCR sealing beads is a plastic protective cap.

Assembly

Caution: VCR components with fixed threads must remain stationary during installation. Do not allow the sealing beads to rotate against the gasket.

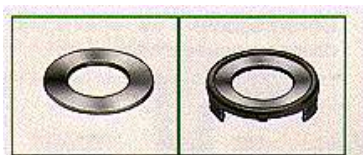

Remove the Original-style Gasket or Gasket Retainer Assembly from its package.



When using an Original-style Gasket, place it into the female nut whenever possible. No special positioning is needed because the gasket is self-aligning.



When using a Gasket Retainer Assembly, press the assembly onto the gland as shown. The retainer assembly will locate the gasket over the bead and hold it in place. Be careful not to scratch or nick the bead. Damage to the bead may cause leakage.



To assemble the connection, hold the male nut or body hex stationary. Tighten the female nut finger-tight.



Mark both the female nut and the male nut or body hex.



Hold the male nut or body hex stationary with a backup wrench. Tighten the female nut 1/8 turn past finger-tight for 316 stainless steel and nickel gaskets or 1/4 turn past finger-tight for copper and aluminum gaskets.

Caution: Excessive overtightening will damage the sealing beads and possibly cause system leakage.



Disassembly

Removing VCR components in an assembled system requires no axial clearance. To disassemble a VCR connection, hold the male nut or body hex stationary with a backup wrench and loosen the female nut. After removing the components, be sure to protect the sealing beads with protective caps or Gasket Retainer Assemblies.

Retightening

To maintain system reliability, install a new Original-style Gasket or Gasket Retainer Assembly on each remake. Simply follow the previously described assembly instructions.

System Configuration

You may configure many aspects of the 373 based on your preferences at the time. For instance, you may easily select which humidity, temperature, and pressure values to indicate on the screen, the order in which they should appear, their units, and whether each will be shown as a number or as a graph. In addition to display configuration, you can also change how the 373 performs its control functions such as Dew/Frost determination, ORIS control, tube heating, mirror pre-cooling, etc. Most configuration settings that you change remain valid until the next time you change them, even if you shut the 373 off.

Menu Options

The 373 has several menus available which are used to configure the system to your requirements. To activate each of the menus, press the lower right menu key. Notice that it is a slightly different color than all the other keys on the touch screen.

Each time you press this menu key, the 373 advances to the next menu and the key's label changes to indicate which menu is currently active. Once you've reached the last menu item, and press the menu key again, the menu options just start over again at the beginning.

Pressing +/- on the keypad steps backward through the menus. Pressing *enter* on the keypad clears all menus from the screen. Note however, that there is no requirement to clear the menus from the screen for any reason other than cosmetic, or for fear of accidentally changing a configured option.

Simplified descriptions of each menu follows.

Parameter	The Parameter menu is used to select which parameter to display on each of the five data lines. Each menu item key contains an arrow and directly corresponds with its adjacent data line.
Numeric / Graphic	The Numeric/Graphic menu is used to toggle a data line between displaying the data as numbers or as a graph. Each menu item key contains an arrow and directly corresponds with its adjacent data line.
Control Setup	The Control Setup menu is used to configure such things as dew/frost control, pump control, internal and external heater control, cooling water control, etc.
Units	The Units menu is used to change units used for displaying data. Unit changes are system global, meaning that if the temperature units are changed, then all temperature values displayed (including dew and frost point temperatures) will appear in the new units. Since there are so many units that may be configured, there are two units menus.
Fore Color	The Fore Color menu is used to temporarily change the color of the lines drawn on graphs and the color of text (number and letters). Each data line may be changed individually. Unlike other selections, changing colors is only temporary and cycling the power causes the 373 to return to standard color settings.
Back Color	The Back Color menu is used to temporarily change the color of the background drawn on graphs and numeric data lines. Each data line may be changed individually. Unlike other selections, changing colors is only temporary and cycling the power causes the 373 to return to standard color settings.
Analog Outputs	The Analog Outputs menu is used to configure the calibration, scaling, and parameter selection for output of data to the Analog Output connectors on the back panel. Both analog output ports are separately configurable.

Display Parameters

Use the Parameters menu to select which parameters to display on the data lines. When you select parameters for display on any of the five data lines, those selections remain valid until you change them again, even if you turn the 373 off. See *Selecting Parameters to Display* on page 6 to select which values to display. A list of the available parameters follows. Note that not all parameters are available on all systems since some systems may not contain the associated hardware components.

Dew Point
Frost Point
%RH
%RH WMO
Volume Ratio
Weight Ratio
Absolute Humidity
Specific Humidity
Vapor Pressure
Atmospheric Pressure
Head Pressure
Flow Rate
External Temperature
Head Temperature
Precooler Temperature
Block Temperature
Internal Tube Temperature
External Tube Temperature
Mirror Temperature

Graphing Data

Any value that you can view numerically can also be viewed as a graph at any time. The 373 automatically maintains a short history of each and every selectable parameter so that a graph may be seen instantly whenever a data line is toggled from a numeric mode to a graph mode.

Selecting Between Numeric Data and Graph

Selecting between numeric and graph modes is done with the Numeric / Graphic menu. See *Selecting Graph vs. Numeric Data* on page 6.

Changing Graph Attributes

You can change the overall time span (or x-axis) and the scaling (or y-axis) attributes of graphs.

Time Span

Changing the time span allows you to see a longer or shorter history period for the data. The 373 stores a fixed number of data points independent of the selected time span. Changing the time span changes the interval used for data storage. With a 15 minute time span, the graph data is sampled and stored every few seconds. However, with a 2 hour time span, the graph data is only sampled, stored, and updated about once a minute.

When you change the time span, the old data previously sampled and stored at the old interval will be incrementally replaced by new data sampled at the new interval. The Time Span as indicated on the graph will always reflect the actual time span of the currently stored data, and will eventually agree with the time span you select. The selected time span is common to all graphs so that they all have the same time relationship to one another.

The time span is changed with the Numeric/Graphic menu.

1. Use the lower right menu key to select the Numeric/Graphic menu. 'Numeric/Graphic' appears on the key, and the key directly above it shows 'Time Span'.
2. Press the Time Span key. A dialog box appears for entry of the desired time span.
3. Use the numeric keypad to enter a new value. As you press each numeric key, the numbers appear in the white Change To field of the dialog box.
4. If you make an entry error, press the touch screen over the field that holds the number you wish to change. Each time you press the touch screen there, the number backspaces one digit. Use this technique to erase any unwanted digits, then continue with the keypad use.
5. Press the dialog box's Ok button to accept the new value, or press Cancel to leave it unchanged. Note that pressing *enter* on the keypad does the same as pressing the Ok button.

The result will not be instant. It will take some time for the old data at the old time interval to be replaced by data at the new time interval as determined by your selected time span.

Scaling

Each graph can have its own scaling (or y-axis) values. There are three distinctly different scaling modes to choose from.

- *Autoscale*

Autoscale mode determines the scaling automatically so that all of the stored data will be visible on the graph at the best possible resolution. As the range of the data changes, so does the range of the graph. In autoscale mode, you can select a minimum that you want the graph to scale to. This is very useful for data that is very stable with little variation. This prevents the 373 from setting the scaling to such a small range that even the highly stable data appears visibly as wildly variable. For viewing dew or frost point graphs, setting this Autoscale Minimum to a value of at least 0.2 or more is generally preferable. This allows the graph range to close in on the data as it stabilizes at a point without becoming too narrow. You can experiment with this value to determine your personal preferences with different parameters. Autoscale mode is the power up default.

- *Fixed Range*

Fixed Range scaling allows you to select a fixed graph range, but automatically centered on the current data point. In other words, as the current data varies so does the graph center point, but the overall range remains fixed. This fixed range auto centering is mostly used to monitor data for stability.

- *MinMax*

You can specify the minimum and maximum values used for the graph. This is completely fixed scaling. If the data falls outside the minimum and maximum values you specify, you will not see them on the graph. If you wish to see the data that is outside the values you specified, you'll need to specify minimum and maximum values with a larger spread.

You can change the graph scaling at any time, and freely switch between the three scaling modes as well. Try it.

1. Using the touch screen, press directly on the graph you wish to change. A graph scaling dialog box will appear. One of the buttons in the Description column will have a green indicator. That shows you the currently selected mode. Note that there are three buttons – one for each mode.
2. Press the button of the mode you'd like to change to. Note that for the MinMax option, only the Maximum button need be pressed (as Minimum is then automatically assumed).
3. Press the corresponding button in the Change To column for the range you selected.

- Using the numeric keypad, enter the value needed. If the number shown in the Value column is already correct, no entry is needed here. If you make a mistake while entering the value, use the touch screen and press on the number in error. Each time you press the touch screen there, the number will backspace one, erasing the flawed digits.
- Once the value is shown is what you want press the Ok button (or the enter key) to accept the new value, or press the Cancel button to abort all changes made to the mode and to any values.

The only values that get accepted by the system are those that correspond with the selected mode. In other words, if you change the value of the Autoscale Minimum, but Fixed Range is the selected mode, the Autoscale Minimum value remains unchanged.

Viewing Data both as Numeric and as a Graph

Since all displayable data may be viewed either numerically or as a graph, it does not matter which parameters are selected on which lines of the display. Often times you may even want to select the same parameter on two different data lines. That way you can have one of them set for numeric mode and the other one showing you a graph of that same data.

Control Setup

With the Control Setup, you can control the manner in which the 373 operates. The control setup capabilities are accessible through the Control Setup menu. See Navigating the Menus on page 5.

Dew / Frost Control

The 373 can control on either dew point or frost point, and has the ability to distinguish the difference through a function known as Force Frost. The Dew / Frost Control setup menu is used to control the Force Frost function and also allows for setup of the ORIS (Optimal Response Injection System) operation.

Force Frost Below

For mirror temperatures above 0°C, water vapor condenses on the mirror as liquid water (dew). A condensation layer resulting from a mirror temperature above 0°C is considered a dew point.

For mirror temperatures far below 0°C (generally mirror temperatures below -40°C), water vapor condenses on the mirror as solid ice (frost). A condensation layer resulting from a mirror far below 0°C is considered a frost point.

However, for mirror temperatures between 0 and approximately -30°C, the state of the condensed layer is generally indeterminate since dew can, and does, exist on the mirror in a meta-stable state at temperatures well below 0°C. In reality, the condensed layer on the mirror could be dew, frost, or some combination of the two. Significant errors can result if wrongful assumptions are made and can be in excess of 2°C.

To eliminate this problem, the 373 can automatically force all sub-zero condensation to a known state of frost using the Force Frost function. Force Frost works by rapidly cooling the mirror below -40°C forcing the condensate to solidify to a layer of ice or frost. The mirror will then re-stabilize at the frost point temperature. Once the condensed layer is in a state of frost, it will remain frost for all sub-zero mirror temperatures.

You can enable or disable the Force Frost function, and also decide at which temperature it begins to work. From the Control Setup menu, press Dew/Frost Control (the top menu key). Change the value of the *Force Frost Below* field. Mirror temperatures below this value will be forced to frost.

Now enable or disable the Force Frost function by pressing the *Force Frost Below* button. A green indicator light on the button means that the function is enabled. If the light is not illuminated, then the Force Function is disabled, and no Force Frost will be performed. Complete your preference by pressing *Ok* or the keypad's *enter* key.

Enable ORIS Below

The Optimal Response Injection System is used to speed system response for very low frost point measurements typically when the gas is drier than approximately -60°C . ORIS works by momentarily injecting a small amount of water vapor into the dry gas stream to rapidly seed the initial formation of frost on the mirror. This process allows the required layer to build within a matter of minutes rather than hours. ORIS is typically used for frost point measurements below about -60°C , but allows you to set it to any reasonable value.

You can enable or disable the ORIS function, and also decide at which temperature it begins to work. From the Control Setup menu, press Dew/Frost Control (the top menu key). Change the value of the *Enable ORIS Below* field. Mirror temperatures below this value, when there is not yet any frost formation on the mirror, will use ORIS to more rapidly form the initial frost layer.

Now enable or disable the ORIS function by pressing the *Enable ORIS Below* button. A green indicator light on the button means that the function is enabled. If the light is not illuminated, then ORIS is disabled, and no rapid layer formation will be performed. Complete your preference by pressing *Ok* or the keypad's *enter* key.

Mirror Cleaning Control

When the fixed Mirror Cleaning key at the bottom of the screen is pressed, the mirror immediately warms to a pre-specified temperature, readying the measuring head for removal of the cover and optical assembly. If the mirror and other internal measuring head components become exposed to normal atmospheric air while cold, the possibility of undesired condensation exists. By warming the mirror and other internal components to a safe head removal temperature prior to accessing the mirror, this adverse condensation is avoided.

The safe temperature to which the mirror and internal components will be warmed during a Mirror Cleaning procedure is selectable from the *Mirror Cleaning* key of the *Control Setup* menu. Enter a value between 20 and 50°C for the *Min Head Removal Temp*.

Mirror Check Control

Mirror Check is the process of warming the mirror to evaporate all condensation, look for the presence of contamination and account for it if necessary, then re-initiating a new dew or frost point measurement. Mirror Check may be initiated manually with the fixed Mirror Check key, or if enabled to do so, it may trigger automatically at pre-specified time intervals. During a mirror check function, whether triggered automatically or manually, the fixed mirror check key indicates red while heating, brown while holding at the high temperature, then yellow while allowing the mirror to cool to reform the dew or frost layer again. Once the system has again established a dew or frost layer, and become stable at that value, the mirror check function is complete and the color indications are removed. To view or edit the Mirror Check parameters, press the *Mirror Check* key of the *Control Setup* menu.

Cycle Time

If Automatic Mirror Check is desired, enable it by pressing the Cycle Time button. A green light on the Cycle Time button indicates that automatic mirror check is enabled. Even if automatic mirror check is not enabled, manual mirror check may be initiated at any time simply by pressing the fixed Mirror Check key at the bottom of the screen. When automatic mirror check is enabled, the fixed Mirror Check key also displays a countdown timer indicating the time until the next automatic mirror check function.

Changing the Cycle Time changes the time interval between automatic mirror check operations.

Heating Time

The Heating Time determines how long to hold at the mirror check temperature before allowing another dew or frost point measurement. A heating time of 0 results in no hold, meaning that once the mirror check temperature has been reached, the function ends and dew/frost control resumes immediately. If a heating time greater than 0 is entered, then the mirror will heat and remain at that temperature for the duration of the heating time value. Heating time is effective regardless of whether mirror check was triggered automatically or manually.

Heat To

Edit the Heat To field to change the temperature that the mirror will be heated to, and optionally held at, during Mirror Check.

Pump Control

The pump, if your system is so equipped, is a diaphragm type driven by a brushless DC motor. Pump speed, and thus flow rate, is controlled by changing the amount of power applied to the motor. Pump power can be set from 0 to 100%, accessed through the *Pump* key of the *Control Setup* parameters menu. When connections to the system are made with short tubing of ¼" diameter resulting in very little flow restriction, settings for pump power of 10 to 25% are often acceptable. However for long tubing runs, small tubing diameters, or when restrictions are induced (by externally installed flow meters for instance) higher pump power settings may be required. Experiment to determine the lowest pump power setting needed to obtain the desired flow rate. Turn the pump on and off with the fixed *Pump* key.

Depending on your system configuration, a pump may not be needed. Or if a pump is installed, it may not necessarily need to be enabled if you are sampling from a positive pressure system. The pump, if installed, is configured with forward flowing check valves that open easily. This allows even a slight positive pressure to be used flow gas through the head, even if the pump is installed but not enabled.

Heater Controls

For the purpose of measuring high dew points, some units are optionally equipped with controls for heating the measuring head and all internal components in contact with the gas stream. If so equipped, connections are also available for control of external heated hoses to connect between the 373 and the device under test.

The head and all internal components are controlled at a common setpoint. A separate control setpoint is available for the external heated hoses. Both areas may be controlled either at fixed setpoints, or at some delta temperature above the current mirror temperature, and may be enabled/disabled independently.

Access to the setpoints, control modes, and enabling is through the *Heater* key of the *Control Setup* menu. The green light indicates whether control is enabled, and whether it operates with a fixed setpoint or at some delta above the mirror temperature. When no lights are on for a particular control group, that heater is disabled. It is also possible to run one heater group in a fixed setpoint mode, with the other running in delta mode. Since the measuring head (and internal component) heating is completely independent from the heating of the external heated hose, any combination of control is acceptable. But keep in mind that all components, including external fittings and interconnects must also remain above the dew point of the gas being measured to prevent condensation with the tubing.

Once enabled at the desired fixed or delta setpoints, turn the heaters ON of OFF from the fixed *Heater* key.

Notes:

1. While it may not be evident from front panel indications, all systems automatically control the Head Temperature to maintain it at or above 20°C regardless of the on, off, or enabled status of the heater controls. This is done to prevent the head from cooling to a value that might allow condensation to form on the external head components such as the cover screw or optical head.

2. All systems, including L and LX models, are equipped with controls for the head heater even if not equipped with external tube heater controls. This is done to allow those systems to automatically maintain the head temperature at or above 20°C as mentioned in the previous note. If you enter a head heater setpoint, enable the control, and turn on the heater, you may heat the head to values higher than 20°C. The main purpose for this ability is to allow you to drive excess water from the measuring head if you suspect it of being wet for any reason.

Cooling Control

Heat is generated by the cooling action of the Peltier element used for mirror temperature control. Depending on the measurement range of the system, it will be equipped with an air/water cooling combination or a refrigerant system. Air cooling is accomplished with a speed controlled fan. Lower mirror temperatures produce more heat, resulting in increased fan speed. Fan control is automatic and there are no user controls or adjustments for air cooling.

Water Cooling

Air cooled systems are also generally equipped with an auxiliary water cooling capability. If so equipped, the left fixed key will be labeled Water Cooling. Pressing that key allows cooling water to flow anytime the mirror is below a pre-specified temperature. When the mirror rises above that temperature, water flow stops and air cooling resumes. You specify that temperature with the *Water Cooling* key of the *Control Setup* menu.

Pre-Cooler (Refrigerated Cooling)

All 373L and 373LX Dew Point Mirrors are equipped with a refrigerant cooling system known as the pre-cooler. The pre-cooler provides direct injection of refrigerant to the hot side of the Peltier element. When equipped with a pre-cooler, the left fixed key will be labeled *Pre Cooler*.

Like the heaters discussed previously, the pre-cooler may be operated in either a fix or delta mode. View or edit the current pre-cooler settings from the *Pre Cooler* key of the *Control Setup* menu. As a general guideline, set the pre-cooler fixed mode temperature to a value that is about 20 to 40°C higher than the dew or frost point of the gas being measured. Do not attempt to measure gas with a dew or frost point that is higher than the fixed mode setting. If using delta mode, about 30° is a good choice. In delta mode, the pre-cooler will automatically adjust depending upon the value of the measured dew or frost point.

The refrigeration compressor is protected by a circuit breaker mounted on the back panel above the power plug. You must ensure that this circuit breaker is ON for the refrigeration compressor of the pre-cooler to operate. This breaker affects the pre-cooler's compressor only and does not affect power to any other part of the system.

Turn the pre-cooler ON/OFF from the fixed *Pre Cooler* key.

Changing Units

You can display system data in any of a wide variety of units. When you make a new units selection, that selection remains until you change it again. To change units, follow the instructions given in the Selecting Units section on page 6. Units selections are global across the system, meaning that all values of that parameter type change to reflect the chosen units. For instance, changing the temperature units to °C forces *all* temperature data to appear in °C.

Note:

Data retrieved via RS-232 will *always* be in SI units regardless of the units chosen for display. Also note that settings within dialog boxes used for changing system parameters are also entered and displayed in SI units. Units only affects the five data lines of the normal display window.

Temperature Units

Temperature values may be displayed in units of °C, °F, or K. When changing temperature units, all temperature values, whether displayed as numeric or in a graph, change to reflect the new units selection. Notice that the chosen units will appear on the screen both on the units selection key and next to any temperature related values currently displayed.

Pressure Units

Pressure values may be displayed in units of Pa, hPa, kPa, MPa, atm, bar, mb, inHg, mmHg, cmHg, inH₂O, mmH₂O, cmH₂O, Torr, and psia. . When changing pressure units, pressure values (not including vapor pressure), whether displayed as numeric or in a graph, change to reflect the new units selection. Notice that the chosen units will appear on the screen both on the units selection key and next to any pressure related values currently displayed.

Flow Rate Units

The gas flow rate may be displayed in units of l/min, ml/min, l/h, cfm, and cfh. When changing flow units, an indicated flow rate will change to reflect the new units selection, whether displayed numerically or as a graph. Notice that the chosen units will appear on the screen both on the units selection key and next to the flow rate when displayed.

Volume Ratio Units

Humidity expressed as a volume ratio may be displayed in units of PPM_V (Parts Per Million by Volume) or PPB_V (Parts Per Billion by Volume). When changing these units, volume ratio will change to reflect the new units selection, whether displayed numerically or as a graph. Notice that the chosen units will appear on the screen both on the units selection key and next to the volume ratio when displayed.

Weight Ratio Units

Humidity expressed as a weight ratio may be displayed in units of PPM_W (Parts Per Million by Weight) or PPB_W (Parts Per Billion by Weight). When changing these units, weight ratio will change to reflect the new units selection, whether displayed numerically or as a graph. Notice that the chosen units will appear on the screen both on the units selection key and next to the weight ratio when displayed.

Absolute Humidity Units

Absolute humidity may be displayed in units of g/l, g/m³, and lb/ft³. When changing these units, absolute humidity will change to reflect the new units selection, whether displayed numerically or as a graph. Notice that the chosen units will appear on the screen both on the units selection key and next to absolute humidity when displayed.

Specific Humidity Units

Specific humidity may be displayed in units of g/g, g/kg, and lb/lb. When changing these units, specific humidity will change to reflect the new units selection, whether displayed numerically or as a graph. Notice that the chosen units will appear on the screen both on the units selection key and next to specific humidity when displayed.

Vapor Pressure Units

Vapor pressure may be displayed in units of Pa, hPa, kPa, MPa, atm, bar, mb, inHg, mmHg, cmHg, inH₂O, mmH₂O, cmH₂O, Torr, and psia. . When changing vapor pressure units, vapor pressure will change to reflect the new units selection, whether displayed numerically or as a graph. Notice that the chosen units will appear on the screen both on the units selection key and next to vapor pressure when displayed.

Changing Color

You are free to change the foreground and/or background color of any data line with the Fore Color and Back Color menus. Access the Fore Color and Back Color menus with the menu selection key discussed in the Menu Keys section on page 4. Like other system settings, these color changes are retained. To revert to the standard system default color scheme, press and hold the 9 key for a few seconds while in the Fore Color or Back Color menu.

Fore Color

Fore color affects the color of number and letters, and the plotting color of graphs. If you change the fore color of a data line that is displayed numerically, the graph attributes of that line are not affected. Likewise, if you change the fore color of a line displayed as a graph, the numeric display attributes of that line are unaffected. Which aspect of the data line that is affected is determined by whether that line is currently displayed as a number or as a graph when changing the fore color.

To change a data line's fore color:

1. Access the Fore Color menu as described in the Menu Keys section on page 4. 'Fore Color' appears on the key, and the keys above contain left pointing arrows. Notice that each key corresponds to the data line it points toward.
2. Press the arrow key corresponding to the data line you wish to change. Notice that the fore color of the data line changes with each press of the key.
3. Change the fore color on any of the other data lines with the same method.

Back Color

Back color affects the background color of number and letters, and the background color of graphs. If you change the back color of a data line that is displayed numerically, the graph attributes of that line are not affected. Likewise, if you change the back color of a line displayed as a graph, the numeric display attributes of that line are unaffected. Which aspect of the data line that is affected is determined by whether that line is currently displayed as a number or as a graph when changing the back color.

To change a data line's back color:

1. Access the Back Color menu as described in the Menu Keys section on page 4. 'Back Color' appears on the key, and the keys above contain left pointing arrows. Notice that each key corresponds to the data line it points toward.
2. Press the arrow key corresponding to the data line you wish to change. Notice that the back color of the data line changes with each press of the key.
3. Change the back color on any of the other data lines with the same method.

Analog Outputs

The 373 is equipped with at least two analog outputs that are independently configurable. For each of the analog outputs, you may easily select which parameter to track and how to scale the selected parameter to the analog output range. These selections are made for each of the analog outputs via the Analog Outputs menu.

1. Access the Analog Outputs menu with the menu selection key discussed in the Menu Keys section on page 4.
2. To access the selections for the first analog output, press the 'Analog Output 1' key. This brings up the appropriate analog output configuration window.
3. Make necessary changes as identified in Selecting Which Parameter to Track and Scaling the Output to the Data below.
4. Follow the same procedures for the second or any subsequent analog outputs as needed.

Selecting Which Parameter to Track

With the appropriate analog configuration window displayed, you may select which parameter to attach to that analog output. The parameter is identified as a number in the Parameter field of the window. Using the following list as a guide, change the parameter field to the number indicated.

For this parameter	Units	Enter this number
Dew Point	[°C]	0
Frost Point	[°C]	1
RH	[%]	2
RH WMO	[%]	3
Volume Ratio	[PPMv]	4
Weight Ratio	[PPMw]	5
SF6 Volume (SF6 only)	[%]	6
Absolute Humidity	[g/m ³]	7
Specific Humidity	[g/kg]	8
Vapor Pressure	[Pa]	9
Atmospheric Pressure (H,HX only)	[Pa abs]	10
Head Pressure	[Pa abs]	11
Relative Head Pressure (H,HX only), or Tank Pressure (SF6 only)	[Pa]	12
Flow Rate	[l/min]	13
External Temperature	[°C]	14
Head Temperature	[°C]	15
Precooler Temperature (L, LX)	[°C]	16
Block Temperature (H, HX)	[°C]	17
Internal Tube Temperature (H, HX)	[°C]	18
External Tube Temperature (H, HX)	[°C]	19
Mirror Temperature	[°C]	20

As an example, suppose that you wish to have %RH output as an analog voltage. Since %RH is identified as parameter 2 in the list, enter the number 2 into the parameter field of the analog configuration window.

Scaling the Output to the Data

With the appropriate configuration window displayed, you may change the data scaling of the analog output vs. the parameter. Continuing with the example in the previous paragraph, assume that you wish to have 0 to +1 VDC on the analog output represent 0 to +100 %RH.

Based on the example,

<i>For this field</i>	<i>Enter this value</i>
Min Value	0
Max Value	100
Min Voltage	0
Max Voltage	1

Depending on the factory configuration and calibration of your specific 373, it may be equipped with one of several different output options. Options have included ± 1 , ± 5 , or ± 10 VDC. Additionally, some units have been equipped with 4-20 mA outputs. While the most common option is ± 10 VDC (with 16-bit resolution), many older units were equipped with ± 5 VDC (with 12-bit resolution). You may wish to experiment with your 373 output to determine which configuration you have.

Voltmeter Connections

Analog output connectors are clearly identified on the instrument back panel. With the analog output parameters selected and properly scaled, connect a cable between the analog output and a voltmeter. Pre-wired cables are available. If you wish to make your own cables, see

Pin	Signal	Position
1	+I	
2	+V	
3	-V	
4	-I	

When the 4-pin LEMO connector is properly assembled, you will notice that the red dot of the connector housing will be aligned at the top between pins 1 and 4.

Analog Outputs on page 24 for pin-out information.

Back Panel Connections

Power Plug

The power requirements are identified on the serial number label on the back of the instrument. Depending on the model, fuse access may also be available on or near the power plug.

Power Switch

Depending on the model, the main power switch will either be mounted on the front panel (L and LX models), or on the back panel near the power plug. Use the power switch to turn the system ON and OFF.

The 373L and LX models contain a refrigeration compressor that is electrically protected with a circuit breaker mounted on the back panel above the power plug. The breaker connects to the refrigeration compressor only and does not affect power to any other part of the system. To use the pre-cooler, this circuit breaker must be ON.

RS-232

The RS-232 connector is used when connecting the 373 to an external computer. Use a standard 9 pin cable to connect between the 373 and a desktop or laptop computer. The cable is wired straight through with pins 1 through 9 of the male end wired to pins 1 through 9 respectively of the female end. The RS-232 extender cable is a common accessory item easily obtained at most any computer accessory dealer.

See Remote Communication on page 33 for complete discussion of the RS-232 command reference and hardware connections.

External Temperature

The External Temperature plug on the back panel is used for connection of an external temperature probe. External temperature measurements are required if certain humidity parameters are to be computed, such as %RH. External temperature measurements are not required for dew or frost point measurements.

If you wish to connect your own thermometers, the 373 requires a 5 pin connector, LEMO (www.lemo.ch) part number FGG 1B 305 CLAD 52. When wiring the cable, note that pin numbering of the socket in the back panel starts at the top and goes counter-clockwise (as viewed from the rear of the unit). When viewing the solder tubs of a disassembled 5-pin LEMO connector, pin 1 is usually identified with a full or partial circle drawn around it. After identifying pin 1, follow the line counter-clockwise from pin 1 to all other pins in succession. Wire the cable according to the following:

Pin	Signal	Position
1	Shield	
2	+I	
3	+V	
4	-V	
5	-I	

When the 5-pin LEMO connector is properly assembled, you will notice that the red dot of the connector housing will be aligned at the top directly above pin 1.

Mirror Temperature

The mirror of the 373 is equipped with two independent temperature sensors. One is used for system measurement and control. The wires of the other sensor are brought directly to the back panel's Mirror Temperature connector and are for your use. Using this connection, you may measure the mirror temperature sensor directly without affecting normal system operation.

The wires internal to the 373 are shielded up to the connector. You must be responsible for any shielding requirements between the connector and your measuring instrument.

If you wish to make a cable for directly measuring the mirror PRT, the 373 requires a 4 pin connector, LEMO (www.lemo.ch) part number FGG 1B 304 CLAD 52. When wiring the cable, note that pin numbering of the socket installed in the back panel starts at the top left corner and goes counter-clockwise (as viewed from the rear of the unit). When viewing the solder tubs of a disassembled 4-pin LEMO connector, pin 1 is usually identified with a full or partial circle drawn around it. After identifying pin 1, follow the line counter-clockwise from pin 1 to all other pins in succession. Wire the cable according to the following:

Pin	Signal	Position
1	+I	
2	+V	
3	-V	
4	-I	

When the 4-pin LEMO connector is properly assembled, you will notice that the red dot of the connector housing will be aligned at the top between pins 1 and 4.

Analog Outputs

Analog outputs are used for connection of external voltmeters or chart recorders. The analog outputs are independently configurable. If you wish to make your own cables, the 373 requires a 4 pin connector, LEMO (www.lemo.ch) part number FGG 1B 304 CLAD 52. When viewing the solder tubs of a disassembled 4-pin LEMO connector, pin 1 is usually identified with a full or partial circle drawn around it. Pin 4 should have no identifier. Wire the cable according to the following:

4-Pin Connector

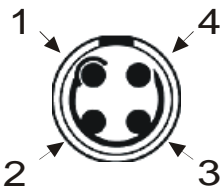

Pin	Position	Signal
1	Top	+V
2	Bottom	-V
3	Bottom	+I
4	Top	-I

When the 4-pin LEMO connector is properly assembled, you will notice that the red dot of the connector housing must be above between pin 1 and 4.

Gas Input and Output

The gas input and output fittings are used for connection of the 373 to the sample gas. Based on the original configuration of your system, it will generally contain 1/4" or 6 mm Swagelok® tube fittings, or 1/4" Swagelok® VCR® metal gasket face seal fittings.

While a connection to the gas input is most likely required, the gas output connection is often left unconnected. If the fittings are capped, you'll need to remove those caps for operation or connection of sample lines.

Hose Heaters

If your system is equipped with controls for external heated hoses, you'll see electrical connectors next to the gas input and output fittings. The connectors mate with those on the heated hose.

Control of the both the input and output heated hoses is based on temperature measurement of the input hose only. Therefore, if a heated hose is connected to the gas output, you must also connect a heated hose to the gas input in order to allow the system to control the hose temperature. For control of the heated hoses, see Heater Controls on page 17.

Barometric Pressure Input

Some systems are equipped with a relative pressure sensor for measurement of the head pressure. On those systems, it is also necessary to accurately measure the barometric pressure so that the absolute pressure of the head may be determined. Systems with a barometric pressure sensor have the pneumatic fitting of that sensor brought to the back panel. This fitting must remain open for operation.

Cooling Water

If your system is so equipped, there are fittings (generally 1/4" or 6 mm brass Swagelok®) on the back panel for connection of auxiliary cooling water. When using these fittings, please note that the water is controlled (on/off) by a solenoid valve which operates at a selectable dew point temperature. It must be allowable for the cooling water to be shut off by the 373's internal solenoid valve. Therefore, cooling water should never be connected in series among multiple systems. Rather, connection of cooling water to multiple systems should be in parallel. To enable use of cooling water and set the temperature at which it turns on, see Water Cooling on page 18.

Measurement Tips

Since each particular 373 model is best suited for a specific dew/frost point range, it is important to have some minimal knowledge of the expected value of the measurement in order to ensure that the proper system is being used. In addition to proper system selection, your success will depend on other factors as well, such as selection and connection of hoses, cooling and/or heating requirements, flow rate, mirror cleanliness, and dew vs. frost determination. These and other topics are discussed here in order to ensure that you achieve success with your measurements.

Determine the Measuring Range

Each 373 has a specific range of operation. To cover the entire range of -95°C frost point to $+95^{\circ}\text{C}$ dew point requires two or more separate instruments with some limited amount of overlap between them. While your instrument may be slightly different, the following should give you some guidelines as to the range of use of the various models.

373 (-60 ... +20 °C)

The standard 373 is generally useful over a measuring range of -60°C frost point to $+20^{\circ}\text{C}$ dew point. The mirror cooling capability and the materials used within the measuring head limit the low end. The room ambient temperature limits the upper end. You should never attempt to measure a dew point temperature that is at or above the temperature of the room. If you do, condensation will form inside the tubing.

373H (-40 ... +70°C)

The 373H is equipped with heated components that allow it to obtain a measuring range of approximately -40 to $+70^{\circ}\text{C}$. The heated components include a heated measuring head, heated flow and pressure sensors, and heated internal and external tubing. Without these heated components controlled at a high temperature, you should never attempt to measure a dew point temperature that is at or above the temperature of the room. If you do, condensation will form inside the tubing. For these high dew point measurements, external heated hoses are also required. For continuous low frost point measurements, or in high ambient temperature environments, cooling water may be supplied from an external source and connected to the system if desired.

373HX (-30 ... +95°C)

For extended high range use, the 373HX is equipped with a high temperature measuring head, heated flow and pressure sensors, heated internal tubing, and controls for heated external hoses. The measuring head is specifically designed for temperatures up to $+95^{\circ}\text{C}$ dew point. For high dew point measurements, external hoses are required. Due to the high range design, the lower end is generally limited to approximately -30°C frost point due to mirror cooling capability and materials used in the design of the measuring head. If cooling water is used, the system may be operable to approximately -40°C frost point.

373L (-80 ... +20°C)

The 373L is designed for low range use, and is equipped with a compact internal refrigeration system. It can measure frost point temperatures down to -80°C , and dew points up to $+20^{\circ}\text{C}$. The 373L can not be used for measuring dew points above room temperature.

373LX (-95 ... +20°C)

The 373LX is designed for extended low range use. It is equipped with a larger internal refrigeration system and a specially designed measuring head allowing it to measure frost point temperatures down to -95°C . Like the 373L, it can only measure dew points up to $+20^{\circ}\text{C}$, and can not measure any dew points above room temperature.

Connecting Hoses

Your success with dew or frost point measurement may likely depend on proper selection and connection of the hoses you use in configuration of your gas sampling system.

Types of Hoses

There are various types of hoses available for use in your gas sampling system. You should consider the suitability for your application.

Teflon

Teflon tubing is flexible, easy to use, and is well suited for frost/dew point measurements in the range of approximately -60 to $+20$ °C. However, for frost point measurements below approximately -60 °C, the hygroscopic effects of Teflon tubing may begin to induce measurement errors due to permeation of water vapor into the gas stream. For dew point measurements above 20 °C, heated hoses will be required.

Stainless Steel

Stainless steel tubing, while less convenient to use, is a good choice for all measurement ranges. For measurement of frost/dew point temperatures below approximately -60 °C, electro-polished stainless steel tubing should be used to reduce dry down times. For extremely low frost point measurements, also keep bends, fittings, and couplings to only the necessary minimums.

Heated Hoses

When measuring dew points that are higher than room temperature, heated hoses will be required. If your 373 is intended to be used for high dew point measurements, it will be equipped with heated internal components and controls for external heated hoses. Once the hoses are connected pneumatically and electrically, you can set the temperature and enable control. See Heater Controls on page 17.

Pneumatic Connections

For high dew point measurements, connect one end of the heated hose to the gas input fitting on the back panel. Connect the other end of the heated hose to the sample gas. When sampling a chamber, insert the end of the hose fully into the chamber if possible.

Wrap a piece of tubular insulation around the exposed fitting between the back panel and the tube's insulating sheath. Insulate all exposed tubes, fittings, and other connections. If any section of tubing cools to a temperature below the dew point of the gas being measured, condensation will occur within the tube, altering the measurement.

If desired, also connect a heated hose to the gas outlet connection of the 373. However, if simply exhausting the gas to ambient, a heated hose on the gas outlet is generally not required. Also note that it makes no sense to put a heated hose on the gas outlet if there is not a heated hose on the gas inlet.

Electrical Connections

Attach the electrical cable from the heated hose to the electrical plug immediately adjacent to the gas fitting. The 373, if properly equipped, will control the temperature of the hose, when enabled, to a specified value.

Hose Input and Output

Preferred Connections

When comparing two or more instruments, make the connections in parallel.

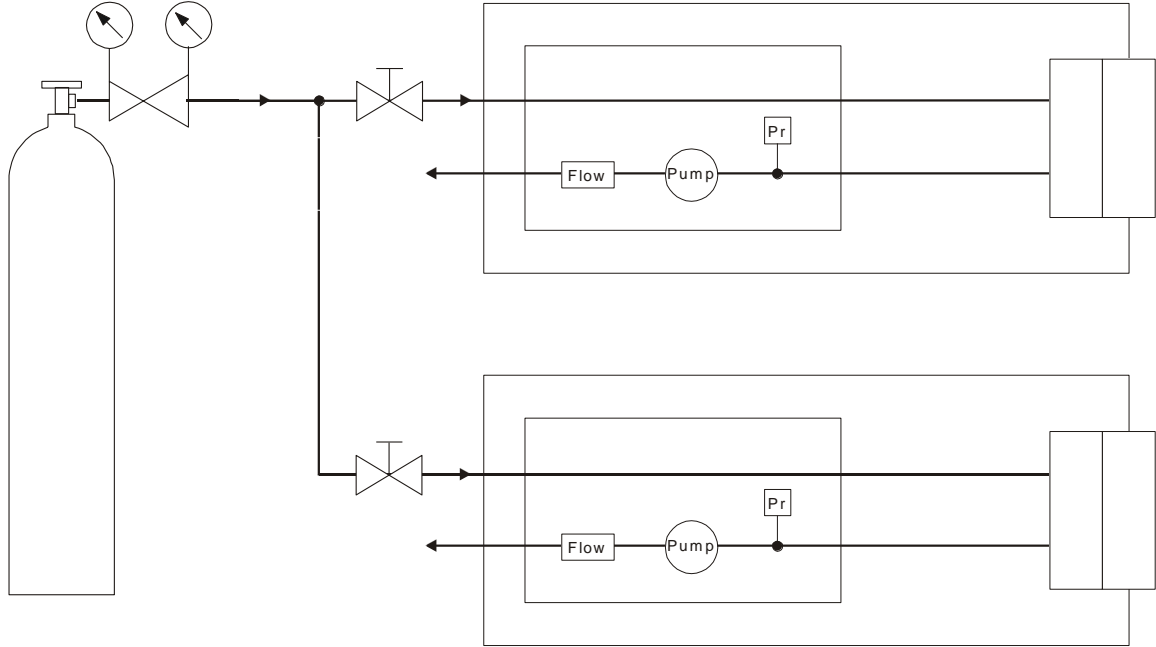

Troublesome Connections

Never connect instruments in series, because of the interference of the two instruments.

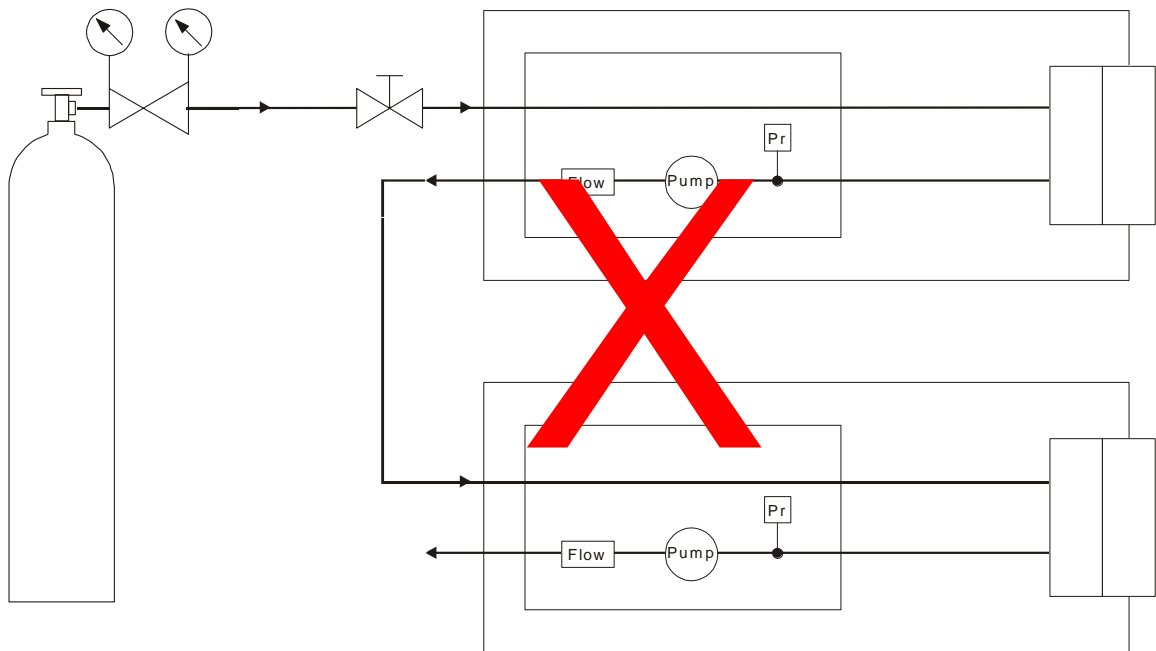

Cooling Requirements

Air Cooling

Mid and high range systems are equipped with air cooling. When air cooled, the fan speed is controlled automatically by the computer. Air cooling is generally sufficient for measurements of frost/dew points from approximately -40 to $+95^{\circ}\text{C}$. Air cooling operates automatically and requires no user input.

Water Cooling

In addition to air cooling, many mid and high range systems are also equipped with auxiliary water cooling connections. Water cooling is useful for mid and high range systems when working at the bottom end of the measuring range below -40°C if air cooling seems to be insufficient. When using water cooling, maintain the temperature of the water above the room ambient dew point to prevent condensation in the measuring head or cooling loop.

Refrigerated Precooler

Low range units, 373L and LX, are equipped with self-contained refrigeration systems for bulk heat removal of the inner elements of the measuring head, allowing those units to reach much lower frost point measurements

Heating Requirements

Head, Block, and Inner Tube Heat

All 373 systems are equipped with head heating. The purpose of head heating is two-fold. First, head heating is used to maintain the head temperature at or above 20°C at all times, regardless of the temperature of the mirror or the temperature of the pre cooler (if so equipped). This minimum 20°C head temperature is controlled automatically, even when the heater is switched off. This is done to prevent condensation of the room air on components of the head that are external to the mirror and gas path. These components include the external portions of the optical assembly, the cover screw, and the measuring head housing.

The alternate purpose of head heating is to maintain the components of the head which are exposed to the gas path above the dew point temperature of the gas. If the head temperature were allowed to fall below the dew point temperature of the gas, condensation could occur within the gas path, thereby corrupting the dew point measurement at the mirror. Head heating is maintained either at 20°C , or at the greater of 20°C and your defined head heating setpoint when the Heater is switched on via the touch screen.

373H and 373HX high range units are equipped with an internal heated block housing the components that come in contact with the gas sample, such as inlet and outlet fittings, pump, flow meter, pressure sensor, and directional valves. In addition, the internal tubes that interconnect the block and the measuring head are also heated. Maintaining these components above the measured dew point temperature of the gas ensures that condensation does not occur in any unwanted internal areas within the gas path. When measuring dew point temperatures higher than room temperature, head heating should be switched on. When heating is switched on, proper heating is maintained on the measuring head, the block, and the internal tubing connected between the block and the measuring head. The head, block, and inner tubes are all maintained at the **Head Temperature** setpoint.

When measuring frost point temperature, or dew point temperatures below approximately 20°C , no heating is required and the heater may remain off (although the head, block, and inner tubes will still be maintained at or above 20°C). When measuring dew point temperatures above 20°C , or above your room temperature, heating is required. Your unit needs to be equipped with the proper heating controls for head, block, and inner tube heat. In addition, you should enter a suitable setpoint and enable heating control. To set the head temperature setpoint and enable heating, see Heater Controls on page 17. Note that only 373H and 373HX systems are equipped with block and inner tube heating controls.

External Hose Heat

The 373H and 373HX systems are equipped with controls for externally connected heated hoses. These external heated hoses allow sampling of gas with a dew point temperature that is higher than room temperature. The external heated hoses are used in conjunction with head, block, and inner tube heater control. Use of an external heated hose connected to the Gas Input is required for high dew point measurements. Connection of a heated hose to the Gas Output is optional and depends on the application. Both hoses are maintained at the same temperature, independent of the head, block, and inner tube temperature.

When measuring frost point temperature, or dew point temperatures below approximately 20°C, no heating is required and the external hose heaters may remain off. When measuring dew point temperatures above 20°C, or above your room temperature, external hose heating is required on at least the Gas Input. Your unit needs to be equipped with the proper external hose heating controls. In addition, you should enter a suitable external hose setpoint and enable heating control. To set the external hose setpoint and enable heating, see Heater Controls on page 17. Note that only 373H and 373HX systems are equipped with external hose heater controls.

Installation

Facility Requirements

Environmental

Your 373 is a precise laboratory quality instrument. While it does not require any special environmental control, it works best when the temperature is stable and free of rapid transitions. For operation, it is best to keep the operating conditions within the following parameters if possible.

Operating Temperature	15 to 35°C
Operating Humidity	5 to 95%RH non-condensing

Power

373L and LX systems have specific power requirements due to the internal refrigeration compressors. Power requirements will be identified on the back panel label.

373S, H, and HX systems are equipped with universal power supplies capable of operation from 100 to 250 VAC at 50 to 60 Hz. However, if these systems are used with external heated hoses, these hoses must be ordered to match your local power source since they operate from the line voltage.

Cooling Water

Cooling water is not required for 373L and LX systems since they are equipped with internal refrigeration systems. The 373S, H, and HX systems are generally equipped with cooling water connections. However, cooling water is rarely required unless you intend to make dew or frost point measurement below approximately -40°C . When used, a recirculating water chiller, or standard tap water, of a temperature between approximately 10 and 20°C may be used. The water cooling connections are either $\frac{1}{4}$ " or 6 mm Swagelok fittings.

Preparation for Use

Prior to first use, the system should be bench or rack mounted and allowed to rest in its normal upright position for several hours prior to applying power. This allows the oil within the compressor of the 373L and LX systems to drain back to its normal location if the system had inadvertently been tipped during transportation. For the 373S, H, and HX systems, this upright requirement does not apply since they have no internal components that are position sensitive.

Benchtop Use

All 373 models are ready for benchtop use. Bench space of at least 24" x 24" (0.6 x 0.6 m) is recommended.

Rack Mounting

Rack mounting kits are available for all 373 models. For 373LX models, simply remove the unit from its current rack mount housing and reinstall it into the rack of your choice. Due to its weight, you should support it on the sides or rear with rack guides that should be available from the supplier of your rack system. For all other models, rack mount adapters are available. Consult the factory for pricing and availability. Also note that for all models, front and rear ventilation access is required.

Preparation for Shipping or Transportation

All shipping and transportation should be done in suitable padded containers. A heavy duty container with at least 2 to 4 inches of clearance for foam padding is recommended.

Due to the design of the 373 systems, any shipping carton used should be constructed to provide support only on the top and bottom of the side panels and on the front and rear frame of the unit. Try not to have any load bearing directly on the face, nor on the top or bottom center of the front or rear frame. Reusable shipping containers are available. Please contact the factory for pricing and availability.

Prior to shipping, always cap the gas inlet and outlet fittings to prevent excess moisture and/or contamination from entering the gas path, and to prevent damage to the fittings.

If applicable, drain the system of any cooling water, or cap the cooling water fittings.

Ensure the optical head assembly and cover screw are firmly attached.

Remote Communication

Introduction

The 373 is equipped with a bidirectional RS-232 communications interface that allows it to be connected to a remote computer. This section is intended to provide necessary information for programming personnel regarding the use of the interface, including the hardware connections, communications settings, and the command syntax.

Hardware Connection & Cabling

Connect a computer to the 373 using a standard *RS-232 9-pin extender cable*. The extender cable has a male connector on one end and a female connector on the other end. It is wired straight through with pins 1 through 9 on one end wired to pins 1 through 9 on the other end. If your computer has a 25-pin serial port connector rather than a 9-pin connector, you'll also need a *25-pin to 9-pin port adapter*. Both the 9-pin RS-232 extender cable and the 25-pin to 9-pin port adapter are commonly available from most computer hardware dealers.

The 373 ignores the DSR and CTS handshaking signals. While there is no harm in connecting all 9 pins, the 373 only requires connection of three of the pins (pins 2=TxD, 3=RxD and 5=GND). For your reference, the complete connector pin-out is listed in the following table. Note that those signals identified by * are required, while the others are completely optional.

Signal	373 (9 pin)	Direction	Computer (9 pin)	Computer (25 pin)
	1		1	8
*TxD	2	→	2	3
*RxD	3	←	3	2
DSR	4	←	4	20
*GND	5	← →	5	7
DTR	6	→	6	6
CTS	7	←	7	4
RTS	8	→	8	5
	9		9	22

* Denotes a required connection. All others are optional.

Communications Settings

To communicate with the 373, set your computer to the following settings.

Baud Rate: 9600
Data Bits: 8
Stop Bits: 1
Handshaking: None

Command Syntax

This section details the general syntax guidelines regarding termination, leading and trailing spaces, case sensitivity, and numeric values. Throughout this section, characters originating from the computer will be shown for illustrative purposes in **this font**. Characters originating from the 373 will be shown in `this font`.

General Usage

All commands require either a question mark or an equal sign to indicate whether you are requesting data or setting new setpoints or parameters. When requesting data from the 373, follow the command with `?`, the question mark character. For example, the following requests the current Automatic Mirror Check timing interval.

```
AMC.cycleTime?
```

The 373 replies with the current AMC cycle time. This value may have been entered from the touch screen or as you will now see, via RS-232.

When setting new values or parameters, use `=`, the equal sign. For example, the following command changes the Automatic Mirror Check timing interval to 20 minutes.

```
AMC.cycleTime=20
```

Most commands that can be set with an equal sign, such as the one in the above example, may also be read with the question mark. That makes sense. However, there are several commands that are considered read only, and have no corresponding ability to be set. Examples of read only capability are measured parameters, such as dew point, frost point, RH, etc.. While it is perfectly valid to read dew point with a command such as `dp?`, it obviously makes no sense to be able to set the dew point value. Therefore, a command such as `dp=1.23` is considered invalid, and will be ignored by the 373.

Termination Characters

All commands must be terminated with either a carriage return C_R or a carriage return linefeed combination $\text{C}_R \text{L}_F$.

Regardless of the command sent, the 373 will reply with a carriage return linefeed $\text{C}_R \text{L}_F$ at the end of the response, provided the command is recognized as valid. Here is an example:

```
DP? $\text{C}_R$                 (sent by the computer to the 373)
-10.015 $\text{C}_R \text{L}_F$         (sent by the 373 back to the computer)
```

Even if the command is not a request for data, but rather is a command to change a setpoint or parameter, the 373 still responds with a carriage return line feed combination. The following turns on the pump (if your unit is so equipped). Notice that no data is returned, but the 373 sends a $\text{C}_R \text{L}_F$ acknowledgement that the command was valid.

```
Pump.on = 1 $\text{C}_R$           (sent by the computer to the 373)
 $\text{C}_R \text{L}_F$                 (the acknowledgement from the 373)
```

However, if the command is unrecognized, the 373 does not respond. See the example.

```
Abcdef? $\text{C}_R$             (invalid command sent from the computer)
(no response from the 373)
```

Leading and Trailing Spaces

The 373 ignores leading and trailing spaces. It also ignores spaces before and after equal signs and question marks. For example, each of the following commands is perfectly valid.

```
Dp?^C_R
Dp ? ^C_R
Pump.on=1^C_R
Pump.on = 1 ^C_R
```

However, the following commands are invalid since spaces are embedded within the keywords.

```
D p?^C_R
Pu mp.on=1^C_R
```

Case Sensitivity

All commands are insensitive to case. In other words, it does not matter if the command is sent in upper case letters, lower case letters, or as some combination of the two. For example, the commands **DP?**, **Dp?**, **dP?**, and **dp?** are identical to the 373 and will return the measured dew point value.

Numeric Values

All numeric data sent to or received from the 373 is done so in either standard or scientific notation. Sending a number as **12.34** is the same as sending it as **1234e-2** or as **1.234e1**. Depending on the value of numeric responses the 373 sends out, it may send the numbers in either standard or scientific notation.

Numeric data is never appended with text of any kind. In other words, if requesting a temperature related value, only the numeric portion of the value is sent. The units are assumed but never sent.

The following table lists the units that numeric data adheres to, regardless of the units selection on the touch screen display or set via the RS-232. In other words, when you change units (even if you changed them via RS-232), you affect only what is seen on the display. All numeric values retrieved from the RS-232 will always be in the following units. Also, when sending data of any kind, do so in these same units.

Parameter	Units via RS-232
Temperature	°C
Pressure	Pa
Flow	l/m
RH	%
Absolute Humidity	g/m ³
Specific Humidity	g/kg
Volume Ratio	PPMv
Weight Ratio	PPMw
PRT Resistance	Ohms

Some values simply require integer numbers such as 1 and 0 for On and Off, while others might need real numbers with a decimal point. The 373 recognizes both types of numbers and will attempt to convert the values you send to the correct format. For example, the number 0 means Off, while 1 or any other real or integer value means On.

Command Reference

The available commands listed here are grouped by function. If a command is considered as a read only value, then it is shown with a question mark only. For instance, the following is considered as read only and does not have the ability to be set.

`Dp?`

A command that has both read and set capability is shown in a slightly different manner. The question mark and equal signs are shown for illustrative purposes within brackets. Those brackets indicate that either one or the other is required. Furthermore, `[=i]` indicates that the value is an integer, while `[=n]` indicates that the value is a real number and may therefore include a decimal point.

Consider a command with syntax listed in the manner

`ForceFrost.on [=i] [?]`

This indicates the following valid possibilities.

`ForceFrost.on = 0`
`ForceFrost.on = 1`
`ForceFrost.on?`

Now consider a command with syntax listed as

`UseOris.below [=n] [?]`

Any of the following are valid possibilities.

`UseOris.below?`
`UseOris.below = -5`
`UseOris.below = -10.25`

Note that a value entered as `-5.00` would be equally as valid as `-5`. While it makes no sense to use a value above 0 for this UseOris example, in general the syntax listing `[=n]` indicates any real number, either positive or negative, with or without a decimal point.

Commands Listed By Functional Group

Measurement Data

<u>Syntax</u>	<u>Function</u>
DP?	Dew Point, °C
FP?	Frost Point, °C
RH?	Relative Humidity, %
RHw?	Relative Humidity (WMO), %
PPMv?	Volume Ratio, PPMv
PPMw?	Weight Ratio, PPMw
AH?	Absolute Humidity, g/m ³
SH?	Specific Humidity, g/kg
VP?	Vapor Pressure, Pa
P?	Head Pressure, Pa
Pa?	Atmospheric Pressure, Pa
Flow?	Flow Rate, l/m
Tx?	External Temperature, °C
Tp?	Precooler Temperature, °C
Tm?	Mirror Temperature, °C
Th?	Head Temperature, °C
Om?	Mirror PRT Resistance, Ohms
Ox?	External PRT Resistance, Ohms

Stability Indication

<u>Syntax</u>	<u>Function</u>
Stable?	1→system is stable, 0→not stable

Force Frost Settings

<u>Syntax</u>	<u>Function</u>
ForceFrost.on [=i] [?]	1 enables Force Frost, 0 disables Force Frost
ForceFrost.below [=n] [?]	Temperature below which Force Frost activates, °C
ForceFrost.coolTo [=n] [?]	Temperature to cool to in order to force frost, °C
ForceFrost.holdBelow [=n] [?]	Keep mirror below this temp during force frost, °C
ForceFrost.dispHold [=i] [?]	1 freezes DP display during Force Frost
SaveCfg=373	Save these and other configuration parameters

Water Valve Settings

<u>Syntax</u>	<u>Function</u>
WaterValve.armed?	1→ valve mode is ready 0→ valve mode is disabled
WaterValve.on?	1→ valve is On, 0→ valve is Off
WaterValve.below [=n] [?]	Temperature below which valve activates, °C
WaterValve.hyst [=n] [?]	Hysteresis amount to prevent valve chatter, °C
SaveCfg=373	Save these and other configuration parameters

ORIS Settings

<u>Syntax</u>	<u>Function</u>
UseOris.on [=i] [?]	1 enables ORIS, 0 disables ORIS
UseOris.below [=n] [?]	Temperature below which ORIS activates, °C
SaveCfg=373	Save these and other configuration parameters

Mirror Cleaning Preparation

<u>Syntax</u>	<u>Function</u>
<code>MinHeadRemovalTemp [=n] [?]</code>	Head and inner cooler are warmed above this temp when Mirror Cleaning button has been pressed prior to head removal, °C
<code>SaveCfg=373</code>	Save these and other configuration parameters

Automatic Mirror Check

<u>Syntax</u>	<u>Function</u>
<code>AMC.on [=i] [?]</code>	1 enables AMC, 0 disables AMC
<code>AMC.cycleTime [=n] [?]</code>	AMC cycle time in minutes
<code>AMC.heatTime [=n] [?]</code>	Time in mins to hold at high temperature during Manual or Automatic Mirror Check
<code>AMC.temp [=n] [?]</code>	Temperature to heat to during Manual or Automatic Mirror Check, °C
<code>AMC.dispHold [=i] [?]</code>	1 freezes DP display during Manual or Automatic Mirror Check
<code>SaveCfg=373</code>	Save these and other configuration parameters

Pump Control Parameters (if available)

<u>Syntax</u>	<u>Function</u>
<code>Pump.on [=i] [?]</code>	1→pump On, 0→pump Off
<code>Pump.freq [=n] [?]</code>	Pump solenoid frequency, Hz
<code>Pump.dutyCycle [=n] [?]</code>	Pump solenoid on/off duty cycle
<code>SaveCfg=373</code>	Save these and other configuration parameters

Head Heater Control

<u>Syntax</u>	<u>Function</u>
<code>HeadHtrPID.on [=i] [?]</code>	1→head heater On, 0→head heater Off
<code>HeadHtrPID.setPt?</code>	Current head temp setpoint, °C
<code>HeadHtrPID.fixedSetPt [=n] [?]</code>	Setpoint for fixed mode control, °C
<code>HeadHtrPID.deltaSetPt [=n] [?]</code>	Setpoint for delta mode control, °C
<code>HeadHtrPID.fixedOn [=i] [?]</code>	1→fixed mode control enabled, 0→disabled
<code>HeadHtrPID.deltaOn [=i] [?]</code>	1→delta mode control enabled, 0→disabled
<code>SavePID=373</code>	Save these and other PID parameters

External Hose Heater Control

<u>Syntax</u>	<u>Function</u>
<code>ExtHtrPID.on [=i] [?]</code>	1→external hose heater On, 0→heater Off
<code>ExtHtrPID.setPt?</code>	Current external hose temp setpoint, °C
<code>ExtHtrPID.fixedSetPt [=n] [?]</code>	Setpoint for fixed mode control, °C
<code>ExtHtrPID.deltaSetPt [=n] [?]</code>	Setpoint for delta mode control, °C
<code>ExtHtrPID.fixedOn [=i] [?]</code>	1→fixed mode control enabled, 0→disabled
<code>ExtHtrPID.deltaOn [=i] [?]</code>	1→delta mode control enabled, 0→disabled
<code>SavePID=373</code>	Save these and other PID parameters

Precooler Control

Syntax	Function
<code>PreCoolerPID.on[=i] [?]</code>	1→Precooler On, 0→Off
<code>PreCoolerPID.setPt?</code>	Current Precooler temp setpoint, °C
<code>PreCoolerPID.fixedSetPt[=n] [?]</code>	Setpoint for fixed mode control, °C
<code>PreCoolerPID.deltaSetPt[=n] [?]</code>	Setpoint for delta mode control, °C
<code>PreCoolerPID.fixedOn[=i] [?]</code>	1→fixed mode control enabled, 0→disabled
<code>PreCoolerPID.deltaOn[=i] [?]</code>	1→delta mode control enabled, 0→disabled
<code>SavePID=373</code>	Save these and other PID parameters

Analog Outputs

See Analog Outputs on page 21 for explanation of the parameters.

Syntax	Function
<code>Ana1.param[=i] [?]</code>	Parameter to track with analog output #1
<code>Ana1.paramMin[=n] [?]</code>	Min Value
<code>Ana1.paramMax[=n] [?]</code>	Max Value
<code>Ana1.OutMin[=n] [?]</code>	Min Voltage
<code>Ana1.OutMax[=n] [?]</code>	Max Voltage
<code>Ana1.calGain[=n] [?]</code>	Gain calibration factor for D/A converter
<code>Ana1.calZero[=n] [?]</code>	Zero calibration factor for D/A converter
<code>Ana1.output=n</code>	Use to set analog output when calibrating D/A converter. Automatically sets <code>Ana1.hold=1</code> . You must send <code>Ana1.hold=0</code> when finished with calibration.
<code>Ana1.hold[=i] [?]</code>	1→Calibration mode. Analog output is set with the command <code>Ana1.output=n</code> . 0→Normal mode. Analog output tracks the parameter set with <code>Ana1.param=i</code> .
<code>SaveCfg=373</code>	Save these and other configuration parameters
<code>Ana2.param[=i] [?]</code>	Parameter to track with analog output #2
<code>Ana2.paramMin[=n] [?]</code>	Min Value
<code>Ana2.paramMax[=n] [?]</code>	Max Value
<code>Ana2.OutMin[=n] [?]</code>	Min Voltage
<code>Ana2.OutMax[=n] [?]</code>	Max Voltage
<code>Ana2.calGain[=n] [?]</code>	Gain calibration factor for D/A converter
<code>Ana2.calZero[=n] [?]</code>	Zero calibration factor for D/A converter
<code>Ana2.output=n</code>	Use to set analog output when calibrating D/A converter. Automatically sets <code>Ana2.hold=1</code> . You must send <code>Ana2.hold=0</code> when finished with calibration.
<code>Ana2.hold[=i] [?]</code>	1→Calibration mode. Analog output is set with the command <code>Ana2.output=n</code> . 0→Normal mode. Analog output tracks the parameter set with <code>Ana2.param=i</code> .
<code>SaveCfg=373</code>	Save these and other configuration parameters

Mirror Temperature Calibration Coefficients

Syntax	Function
MirrorTempCal.r0 [=n] [?]	Callendar VanDusen R0 coefficient, ~ 100.00
MirrorTempCal.a [=n] [?]	Callendar VanDusen A coefficient, ~ 3.9083e-3
MirrorTempCal.b [=n] [?]	Callendar VanDusen B coefficient, ~ -5.775e-7
MirrorTempCal.c [=n] [?]	Callendar VanDusen C coefficient, ~ -4.183e-12
MirrorTempCal.avg [=n] [?]	Amount of averaging applied to measurement, ~40
MirrorTempCal.avgBand [=i] [?]	Only average when measurements remain within this band, ~ 0.2 °C
MirrorTempCal.sensCode [=i] [?]	=42 for 385 RTD
MirrorTempCal.coefType [=i] [?]	=3 for Callendar VanDusen type coefficients
SaveCal=373	Save these and other calibration parameters

External Temperature Calibration Coefficients

Syntax	Function
ExtTempCal.r0 [=n] [?]	Callendar VanDusen R0 coefficient, ~ 100.00
ExtTempCal.a [=n] [?]	Callendar VanDusen A coefficient, ~ 3.9083e-3
ExtTempCal.b [=n] [?]	Callendar VanDusen B coefficient, ~ -5.775e-7
ExtTempCal.c [=n] [?]	Callendar VanDusen C coefficient, ~ -4.183e-12
ExtTempCal.avg [=n] [?]	Amount of averaging applied to measurement, ~40
ExtTempCal.avgBand [=i] [?]	Only average when measurements remain within this band, ~ 0.2 °C
ExtTempCal.sensCode [=i] [?]	=42 for 385 RTD
ExtTempCal.coefType [=i] [?]	=3 for Callendar VanDusen type coefficients
SaveCal=373	Save these and other calibration parameters

Head Temperature Calibration Coefficients

Syntax	Function
HeadTempCal.a0 [=n] [?]	Polynomial 0 th order (Zero) coefficient, ~ 0
HeadTempCal.a1 [=n] [?]	Polynomial 1 st order (Span) coefficient, ~ 0.01
HeadTempCal.a2 [=n] [?]	Polynomial 2 nd order (Linearity) coefficient, ~0
HeadTempCal.a3 [=n] [?]	Polynomial 3 rd order (Linearity2) coefficient, ~ 0
HeadTempCal.avg [=n] [?]	Amount of averaging applied to measurement, ~40
HeadTempCal.avgBand [=i] [?]	Only average when measurements remain within this band, ~ 1°C
HeadTempCal.sensCode [=i] [?]	=37 for 10K thermistor
HeadTempCal.coefType [=i] [?]	=2 for polynomial type coefficients
SaveCal=373	Save these and other calibration parameters

Block Temperature Calibration Coefficients (if so equipped)

Syntax	Function
BoxTempCal.a0 [=n] [?]	Polynomial 0 th order (Zero) coefficient, ~ 0
BoxTempCal.a1 [=n] [?]	Polynomial 1 st order (Span) coefficient, ~ 0.01
BoxTempCal.a2 [=n] [?]	Polynomial 2 nd order (Linearity) coefficient, ~0
BoxTempCal.a3 [=n] [?]	Polynomial 3 rd order (Linearity2) coefficient, ~ 0
BoxTempCal.avg [=n] [?]	Amount of averaging applied to measurement, ~40
BoxTempCal.avgBand [=i] [?]	Only average when measurements remain within this band, ~ 1°C
BoxTempCal.sensCode [=i] [?]	=37 for 10K thermistor
BoxTempCal.coefType [=i] [?]	=2 for polynomial type coefficients
SaveCal=373	Save these and other calibration parameters

Internal Tube Temperature Calibration Coefficients (if so equipped)

Syntax	Function
IntTubeTempCal.a0 [=n] [?]	Polynomial 0 th order (Zero) coefficient, ~ 0
IntTubeTempCal.a1 [=n] [?]	Polynomial 1 st order (Span) coefficient, ~ 0.01
IntTubeTempCal.a2 [=n] [?]	Polynomial 2 nd order (Linearity) coefficient, ~0
IntTubeTempCal.a3 [=n] [?]	Polynomial 3 rd order (Linearity2) coefficient, ~ 0
IntTubeTempCal.avg [=n] [?]	Amount of averaging applied to measurement, ~40
IntTubeTempCal.avgBand [=i] [?]	Only average when measurements remain within this band, ~ 1°C
IntTubeTempCal.sensCode [=i] [?]	=37 for 10K thermistor
IntTubeTempCal.coefType [=i] [?]	=2 for polynomial type coefficients
SaveCal=373	Save these and other calibration parameters

External Tube Temperature Calibration Coefficients

Syntax	Function
ExtTubeTempCal.r0 [=n] [?]	Callendar VanDusen R0 coefficient, ~ 100.00
ExtTubeTempCal.a [=n] [?]	Callendar VanDusen A coefficient, ~ 3.9083e-3
ExtTubeTempCal.b [=n] [?]	Callendar VanDusen B coefficient, ~ -5.775e-7
ExtTubeTempCal.c [=n] [?]	Callendar VanDusen C coefficient, ~ -4.183e-12
ExtTubeTempCal.avg [=n] [?]	Amount of averaging applied to measurement, ~40
ExtTubeTempCal.avgBand [=i] [?]	Only average when measurements remain within this band, ~ 1°C
ExtTubeTempCal.sensCode [=i] [?]	=42 for 385 RTD
ExtTubeTempCal.coefType [=i] [?]	=3 for Callendar VanDusen type coefficients
SaveCal=373	Save these and other calibration parameters

Pre Cooler Temperature Calibration Coefficients

Syntax	Function
PreTempCal.r0 [=n] [?]	Callendar VanDusen R0 coefficient, ~ 100.00
PreTempCal.a [=n] [?]	Callendar VanDusen A coefficient, ~ 3.9083e-3
PreTempCal.b [=n] [?]	Callendar VanDusen B coefficient, ~ -5.775e-7
PreTempCal.c [=n] [?]	Callendar VanDusen C coefficient, ~ -4.183e-12
PreTempCal.avg [=n] [?]	Amount of averaging applied to measurement, ~40
PreTempCal.avgBand [=i] [?]	Only average when measurements remain within this band, ~ 1°C
PreTempCal.sensCode [=i] [?]	=42 for 385 RTD
PreTempCal.coefType [=i] [?]	=3 for Callendar VanDusen type coefficients
SaveCal=373	Save these and other calibration parameters

Absolute Pressure Sensor Calibration Coefficients

Syntax	Function
AbsPressCal.a0 [=n] [?]	Polynomial 0 th order (Zero) coefficient
AbsPressCal.a1 [=n] [?]	Polynomial 1 st order (Span) coefficient
AbsPressCal.a2 [=n] [?]	Polynomial 2 nd order (Linearity) coefficient
AbsPressCal.a3 [=n] [?]	Polynomial 3 rd order (Linearity2) coefficient
AbsPressCal.avg [=n] [?]	Amount of averaging applied to measurement, ~40
AbsPressCal.avgBand [=i] [?]	Only average when measurements remain within this band, ~ 1000 Pa
AbsPressCal.sensCode [=i] [?]	=21 for voltage output sensor
AbsPressCal.coefType [=i] [?]	=2 for polynomial type coefficients
SaveCal=373	Save these and other calibration parameters

Relative Pressure Sensor Calibration Coefficients (if so equipped)

Syntax	Function
RelPressCal.a0 [=n] [?]	Polynomial 0 th order (Zero) coefficient
RelPressCal.a1 [=n] [?]	Polynomial 1 st order (Span) coefficient
RelPressCal.a2 [=n] [?]	Polynomial 2 nd order (Linearity) coefficient
RelPressCal.a3 [=n] [?]	Polynomial 3 rd order (Linearity2) coefficient
RelPressCal.avg [=n] [?]	Amount of averaging applied to measurement, ~100
RelPressCal.avgBand [=i] [?]	Only average when measurements remain within this band, ~ 1000 Pa
RelPressCal.sensCode [=i] [?]	=21 for voltage output sensor
RelPressCal.coefType [=i] [?]	=2 for polynomial type coefficients
SaveCal=373	Save these and other calibration parameters

Flow Sensor Calibration Coefficients

Syntax	Function
FlowCal.a0 [=n] [?]	Polynomial 0 th order (Zero) coefficient
FlowCal.a1 [=n] [?]	Polynomial 1 st order (Span) coefficient
FlowCal.a2 [=n] [?]	Polynomial 2 nd order (Linearity) coefficient
FlowCal.a3 [=n] [?]	Polynomial 3 rd order (Linearity2) coefficient
FlowCal.avg [=n] [?]	Amount of averaging applied to measurement, ~0
FlowCal.avgBand [=i] [?]	Only average when measurements remain within this band, ~ 0 l/m
FlowCal.sensCode [=i] [?]	=21 for voltage output sensor
FlowCal.coefType [=i] [?]	=2 for polynomial type coefficients
SaveCal=373	Save these and other calibration parameters

System Identification

Syntax	Function
ID?	Returns a string containing instrument identification, ie. DPM 373LX
IDN?	Returns only numeric portion of identifier, ie. 373

Saving Changes

Syntax	Function
SaveCfg=373	Save configuration parameters
SaveCal=373	Save calibration parameters
SavePID=373	Save PID parameters

Maintenance

Mirror Cleaning

The heart of the 373 dew point measuring instrument is the measuring head assembly. It is designed to be highly sensitive and accurate, yet rugged and easily accessible for periodic mirror cleaning.

Removing the Head Cover Screw or Retaining Bar



The measuring head is located on the right side of the 373 front panel. To gain access to the mirror and opto-electronic components, you must first remove the cover screw or the retaining bar. The method you use depends on the type of cover provided with your system.

If the cover appears like a large tan colored knurled knob (pictured left), simply twist it counterclockwise. It requires approximately three full turns to completely unscrew, allowing you to remove it.

If the cover is black with two ears, simply loosen the knob in the center a few turns counterclockwise, then twist the metal bar and remove it.

Removing the Optical Assembly



On the extended low range (LX) model, the optical assembly is attached with four hex retaining screws. Carefully remove them with the torque tool provided with your instrument. The four screws are captive within the optical head assembly and will not fall out. For all other models, only the cover screw or retaining bar holds the optical assembly.

Once the retaining bar, cover screw, and any retaining screws have been removed, the black optical assembly (optical head) is now removed by pulling it straight toward you. This piece contains the light emitting and light sensing opto-electronic elements. There is an oval shaped o-ring on the face of the optical assembly that is used to seal it to the measuring head. There are also some gold contacts on the face. Avoid touching the face of the optical assembly with your fingers to prevent contamination of the contacts, the o-ring, the optical area, and the gas channel.



Inspecting / Cleaning the Mirror

The mirror requires occasional periodic cleaning to maintain high accuracy measurements. The flush mounted mirror is easily accessible by removing the cover screw and optical mirror assembly. Look at the mirror with the naked eye or with a magnifying glass. If signs of contamination are present, or suspected of being present, use the following procedure to clean the mirror.

1. Clean the mirror with a clean cotton swab or lint free tissue dampened with distilled water.
2. Follow with a dry cotton swab or tissue.



Although a clean mirror is important to accurate measurements and sound measurement practices, please take the following comments into consideration.

- Never attempt to polish the mirror. It is slightly roughened at the factory to allow for better nucleation sites and thus better dew formation.
- If needed, the mirror may also be cleaned with methanol or alcohol. Always follow the use of these cleaning chemicals with water to ensure they are completely rinsed from the mirror surface.

Reassemble the Mirror Components

Reassemble the mirror components in the reverse order of disassembly.

On the LX model:

1. Install the optical assembly, taking note of the guide pin.
2. Reinstall the four hex retaining screws. Do not tighten yet.
3. Using the torque tool provided, evenly and uniformly tighten the hex screws to the proper torque. You have reached the proper torque when the torque tool clicks. Do not overtighten.
4. Replace the cover screw. Hand tighten until snug. Do not overtighten.

For all other models:

1. Install the optical assembly, taking note of guide pins.
2. Replace the cover screw or retaining bar. Hand tighten until snug. Do not overtighten.

Exterior Cleaning

Front Panel

The 373 front panel is completely sealed and easily cleaned with liquid glass cleaner or other mild cleaning chemicals moistened on a cloth. Clean the front panel periodically as needed.

Rear Fan Grills

The rear fan grills may require cleaning periodically to ensure adequate airflow within the system. Use compressed air to blow dirt and dust from the grill and from inside the system.

Drawings

Dew Point Mirror 373

MBW calibration

9.50	Relative Humidity %	<input type="checkbox"/>
24.693	External Temp. °C	<input type="checkbox"/>
-8.530	Frost Point °C	<input type="checkbox"/>
-9.592	Dew Point °C	<input type="checkbox"/>
-9.56	Dew Point °C	<input type="checkbox"/>
-9.66	Time Span 20.16.30	<input type="checkbox"/>
Balance Indicator	Frost Density	Mirror Residue
STABLE	0	0
Flow Rate l/h	60 30 0	
Water Cooling	Heater	Pump
Mirror Check	Mirror Cleaning	Dew/Frost Control

7	8	9
4	5	6
1	2	3
0	.	exp
+/-	enter	

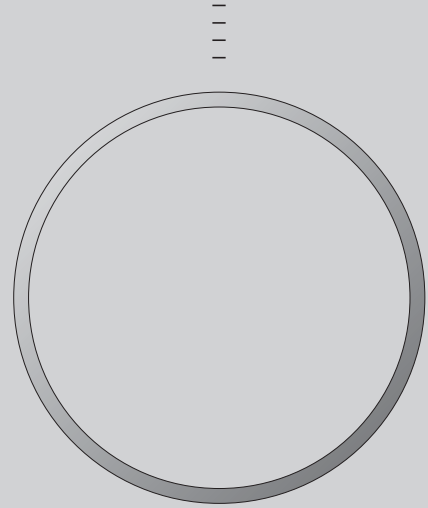

373H Front Panel

SIZE	A4
SHEET	1/1
DOC NO.	373H FP form
DRAWN	DM/gh
SCALE	NO
REV	1.1
DATE	June 29, 2009

MBW calibration



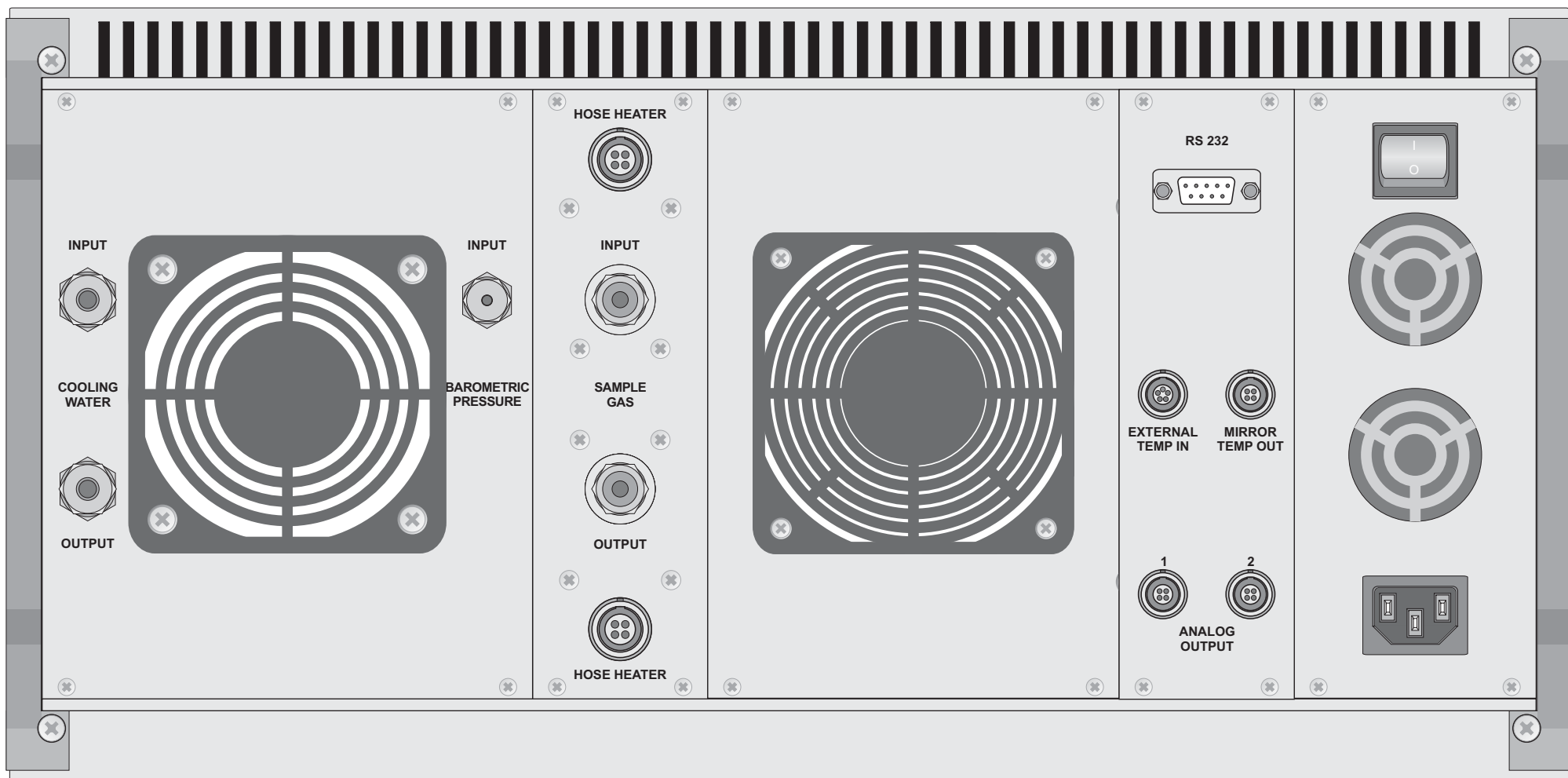

373H/HX Back Panel						SIZE	A4		
						SHEET	1/1		
DOC NO.	373H/HX BP form	DRAWN	DM/gh	SCALE	NO	REV	1.4	DATE	January 16, 2012

Dew Point Mirror 373

MBW calibration

9.50	Relative Humidity %
24.693	External Temp. °C
-8.530	Frost Point °C
-9.592	Dew Point °C
-9.56 °C	Dew Point
-9.66	Time Span 20.16.30
Balance Indicator + STABLE -	Frost Density Hi 0
Mirror Residue Hi 0	Flow Rate l/h 60 30 0
Water Cooling	Heater
Pump	Mirror Check
Mirror Cleaning	Dew/Frost Control

7	8	9
4	5	6
1	2	3
0	.	exp
+/-	enter	

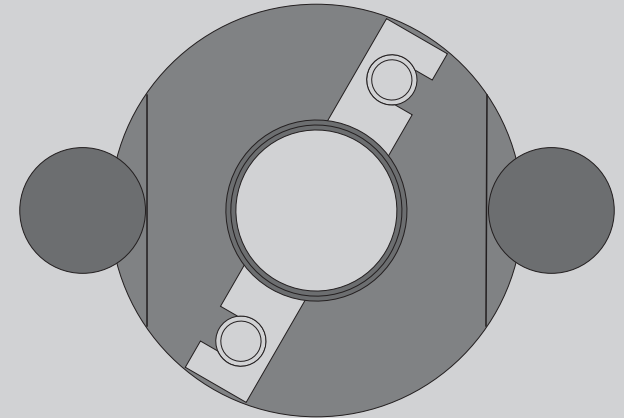

373HX Front Panel						SIZE	A4	MBW calibration — — —	
						SHEET	1/1		
DOC NO.	373HX FP form	DRAWN	DM/gh	SCALE	NO	REV	1.1	DATE	June 29, 2009

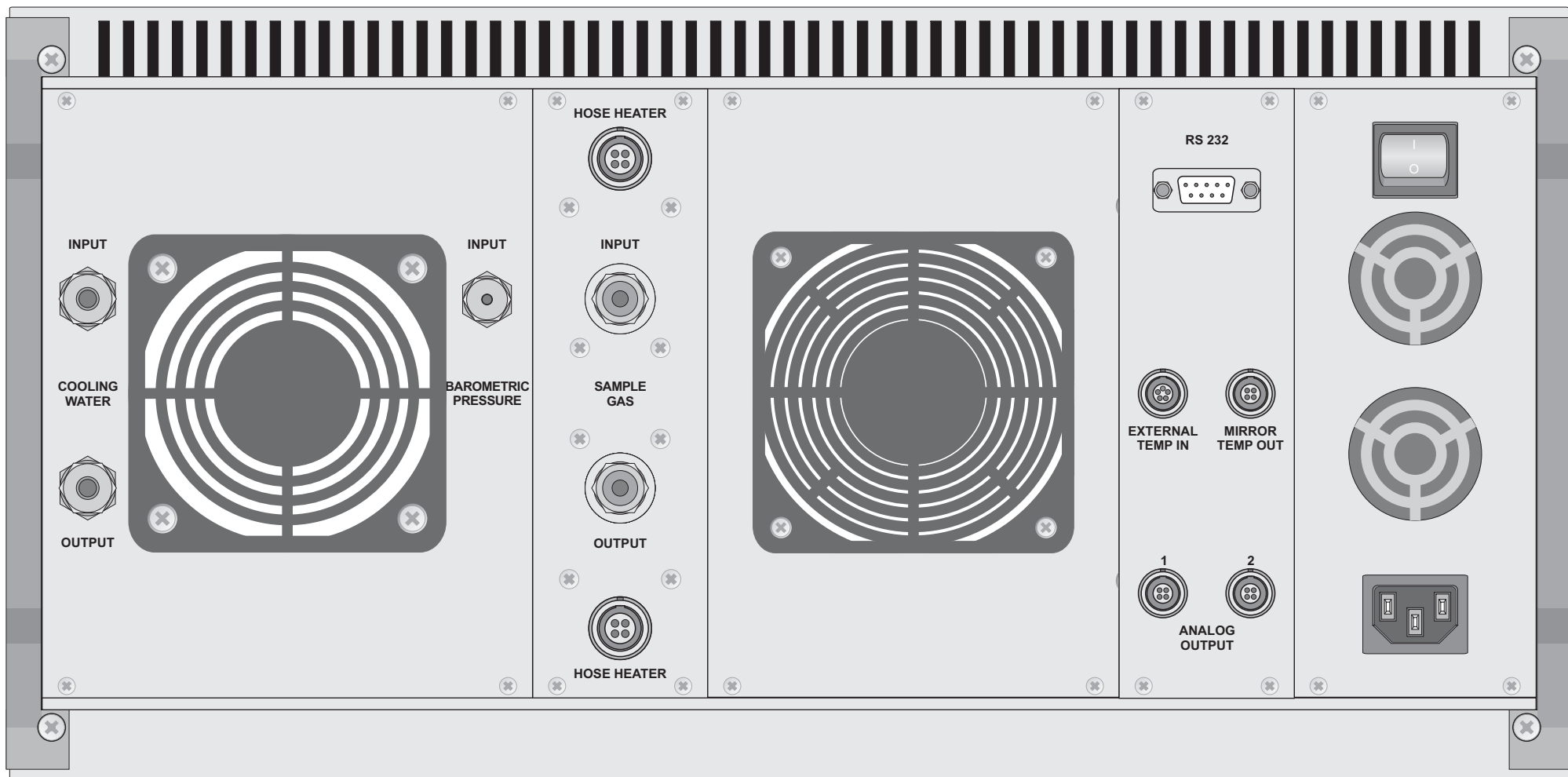

373H/HX Back Panel						SIZE	A4		
						SHEET	1/1		
DOC NO.	373H/HX BP form	DRAWN	DM/gh	SCALE	NO	REV	1.4	DATE	January 16, 2012

Dew Point Mirror 373

MBW calibration

9.50	Relative Humidity %	
24.693	External Temp. °C	
-8.530	Frost Point °C	
-9.592	Dew Point °C	
-9.56	Dew Point °C	
-9.66	Time Span 20.16.30	
Balance Indicator	Frost Density	Mirror Residue
Heater	Pump	Mirror Check
Pre Cooler		Mirror Cleaning
		Dew/Frost Control

7	8	9
4	5	6
1	2	3
0	.	exp
+/-	enter	

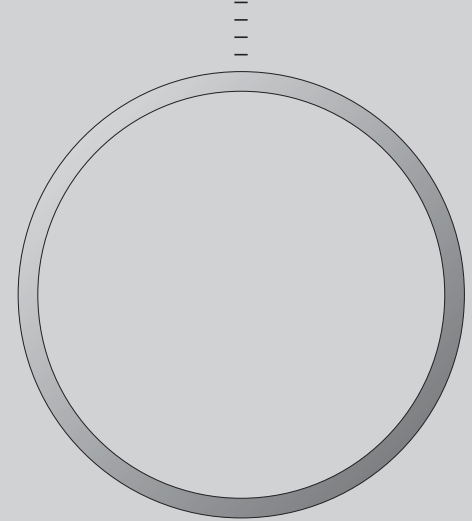

373L Front Panel						SIZE	A4	MBW calibration - - -	
						SHEET	1/1		
DOC NO.	373L FP Form	DRAWN	DM/gh	SCALE	NO	REV	1.1		DATE

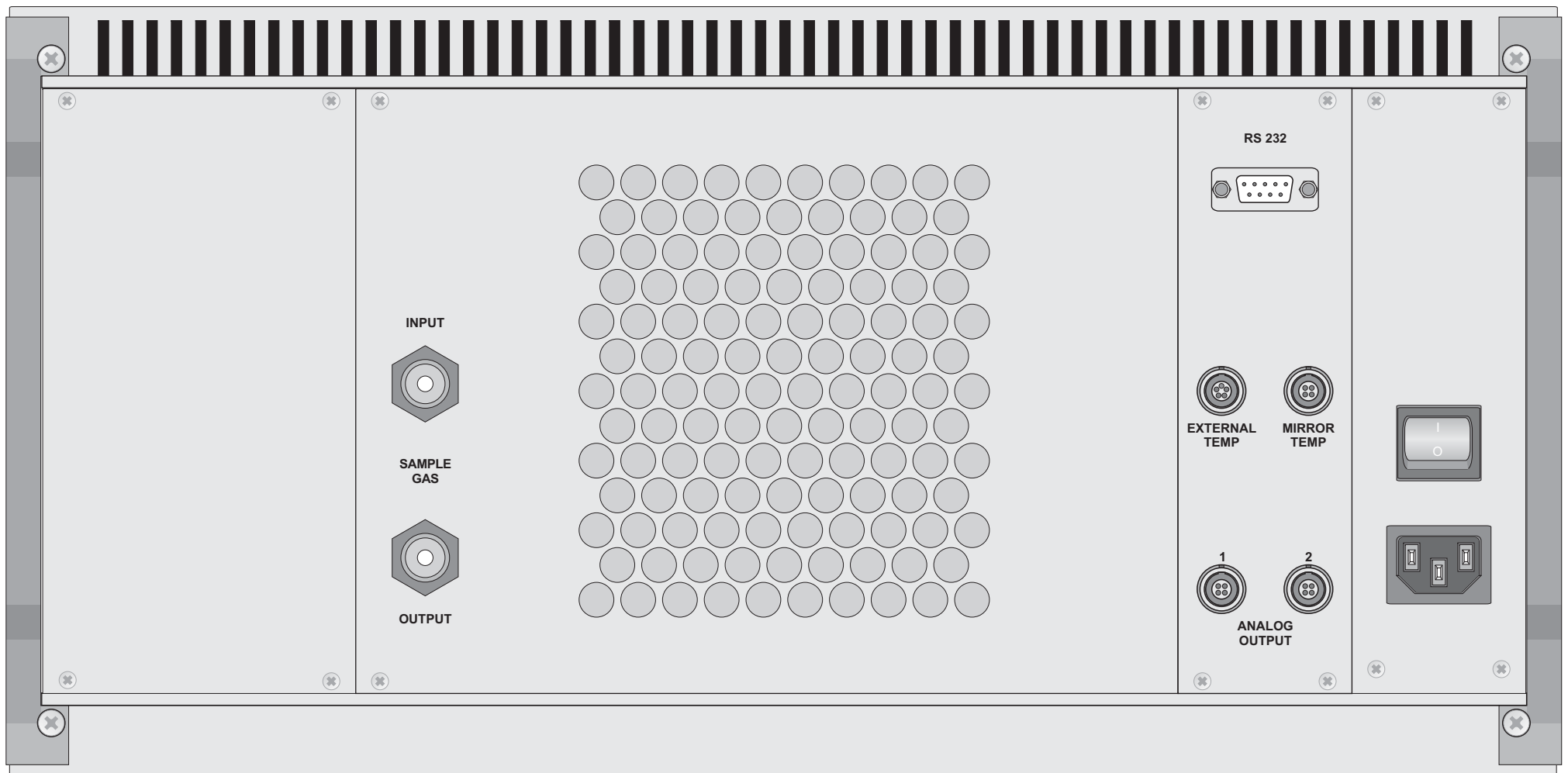

373L Back Panel							SIZE	A4	
							SHEET	1/1	
DOC NO.	373L BP Form	DRAWN	DM/gh	SCALE	NO	REV	1.1	DATE	September 27, 2010

Dew Point Mirror 373

MBW calibration

9.50	Relative Humidity %	<input type="checkbox"/>			
24.693	External Temp. °C	<input type="checkbox"/>			
-8.530	Frost Point °C	<input type="checkbox"/>			
-9.592	Dew Point °C	<input type="checkbox"/>			
-9.56	Dew Point °C	<input type="checkbox"/>			
-9.66	Time Span 20.16.30	<input type="checkbox"/>			
Balance Indicator	Frost Density	Mirror Residue	Flow Rate		
<input type="checkbox"/> STABLE	<input type="checkbox"/> Hi 0	<input type="checkbox"/> Hi 0	<input type="checkbox"/> 60 30 0		
Pre Cooler	Heater	Pump	Mirror Check	Mirror Cleaning	Dew/Frost Control
<input type="checkbox"/>	<input type="checkbox"/>	<input type="checkbox"/>	<input type="checkbox"/>	<input type="checkbox"/>	<input type="checkbox"/>

7	8	9
4	5	6
1	2	3
0	.	exp
+/-	enter	

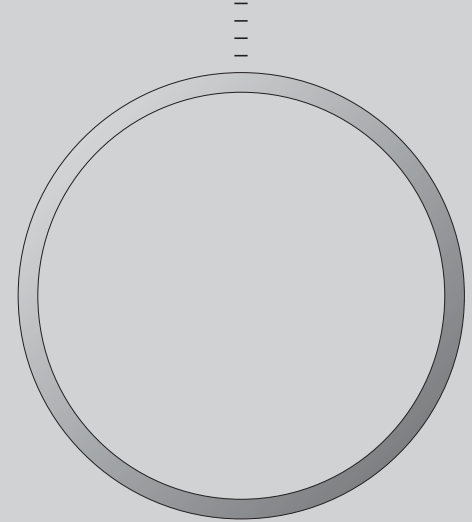

373LHX Front Panel						SIZE	A4	MBW calibration - - -	
						SHEET	1/1		
DOC NO.	373LHX FP form	DRAWN	DM/gh	SCALE	NO	REV	1.1		DATE

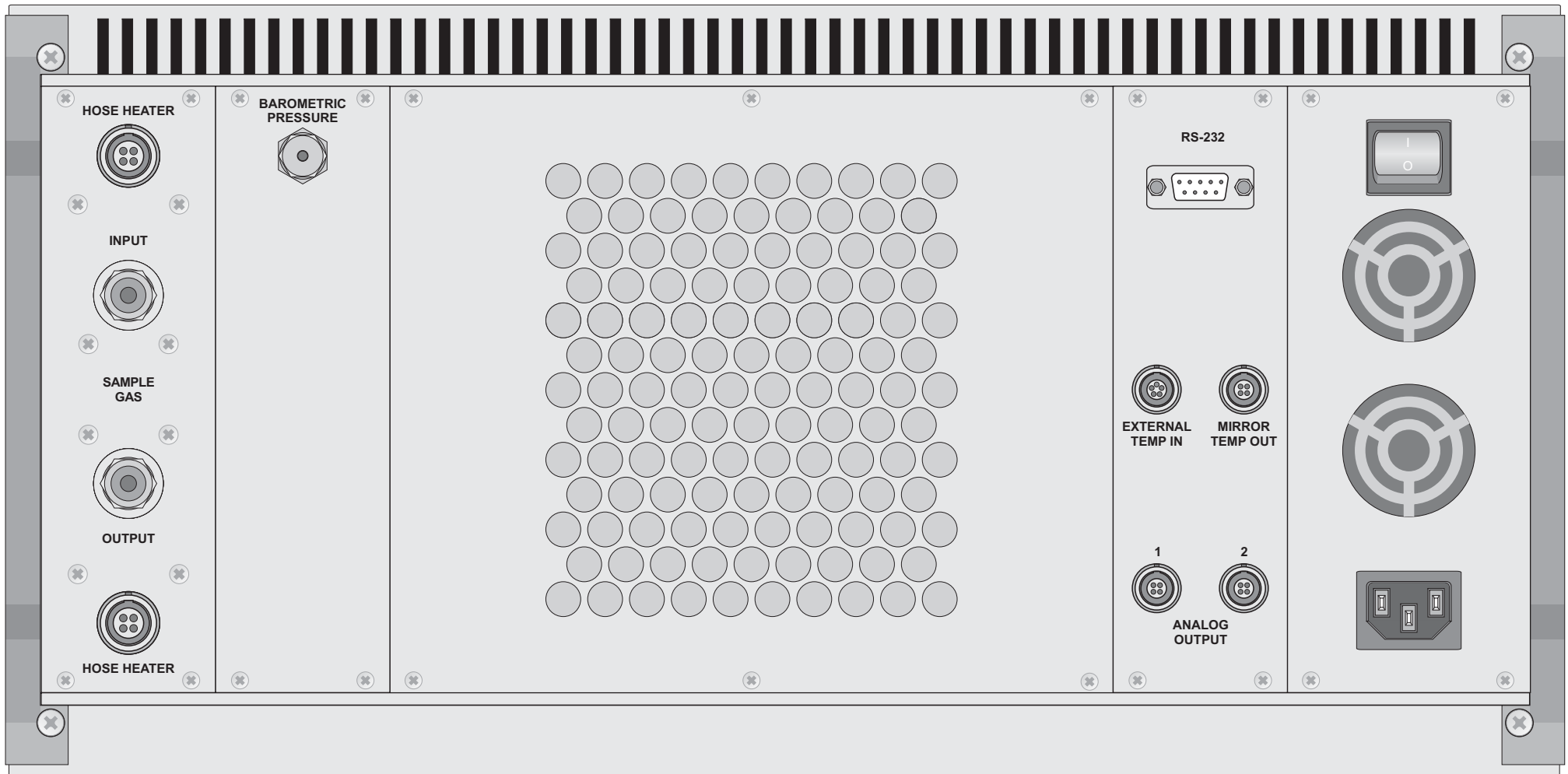

373LHX Back Panel						SIZE	A4		
						SHEET	1/1		
DOC NO.	373LHX BP form	DRAWN	DM/gh	SCALE	NO	REV	1.3	DATE	September 6, 2010

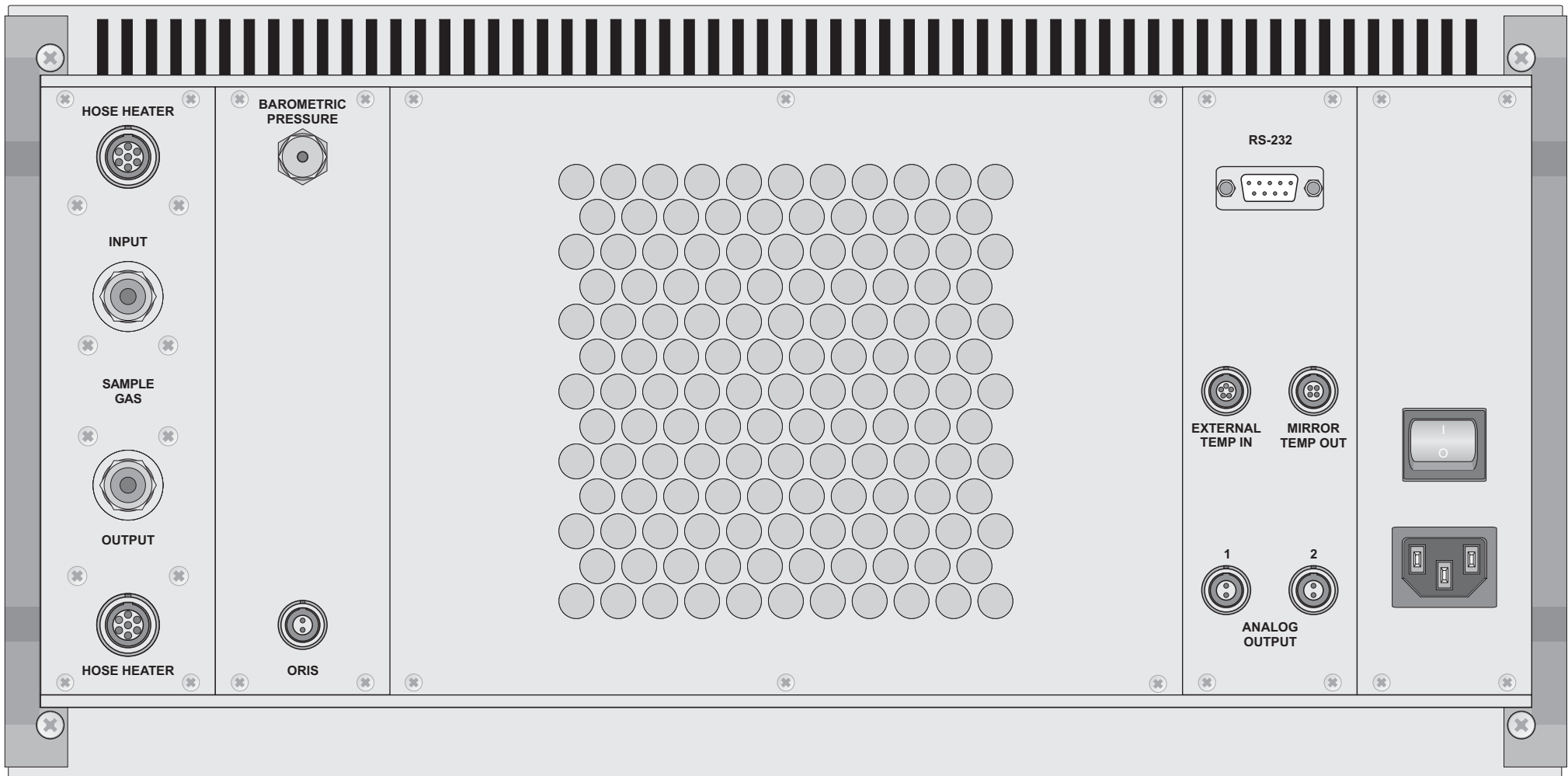

373LHX-ORIS Back Panel						SIZE	A4		
						SHEET	1/1		
DOC NO.	373LHX-ORIS BP form	DRAWN	DM/gh	SCALE	NO	REV	1.1	DATE	June 29, 2009



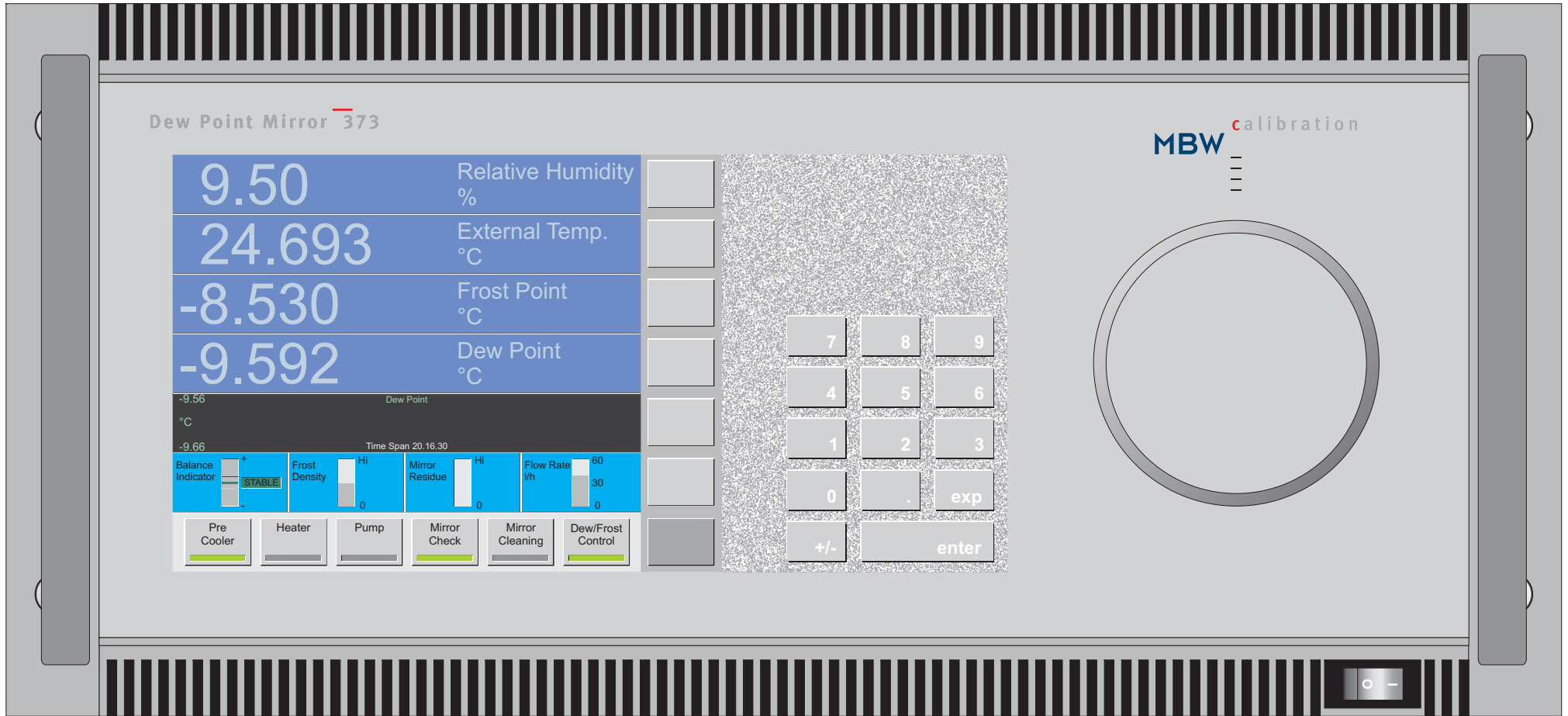

373LX Front Panel						SIZE	A4		
						SHEET	1/1		
DOC NO.	373LX FP Form	DRAWN	DM/gh	SCALE	NO	REV	1.1	DATE	June 18, 2009

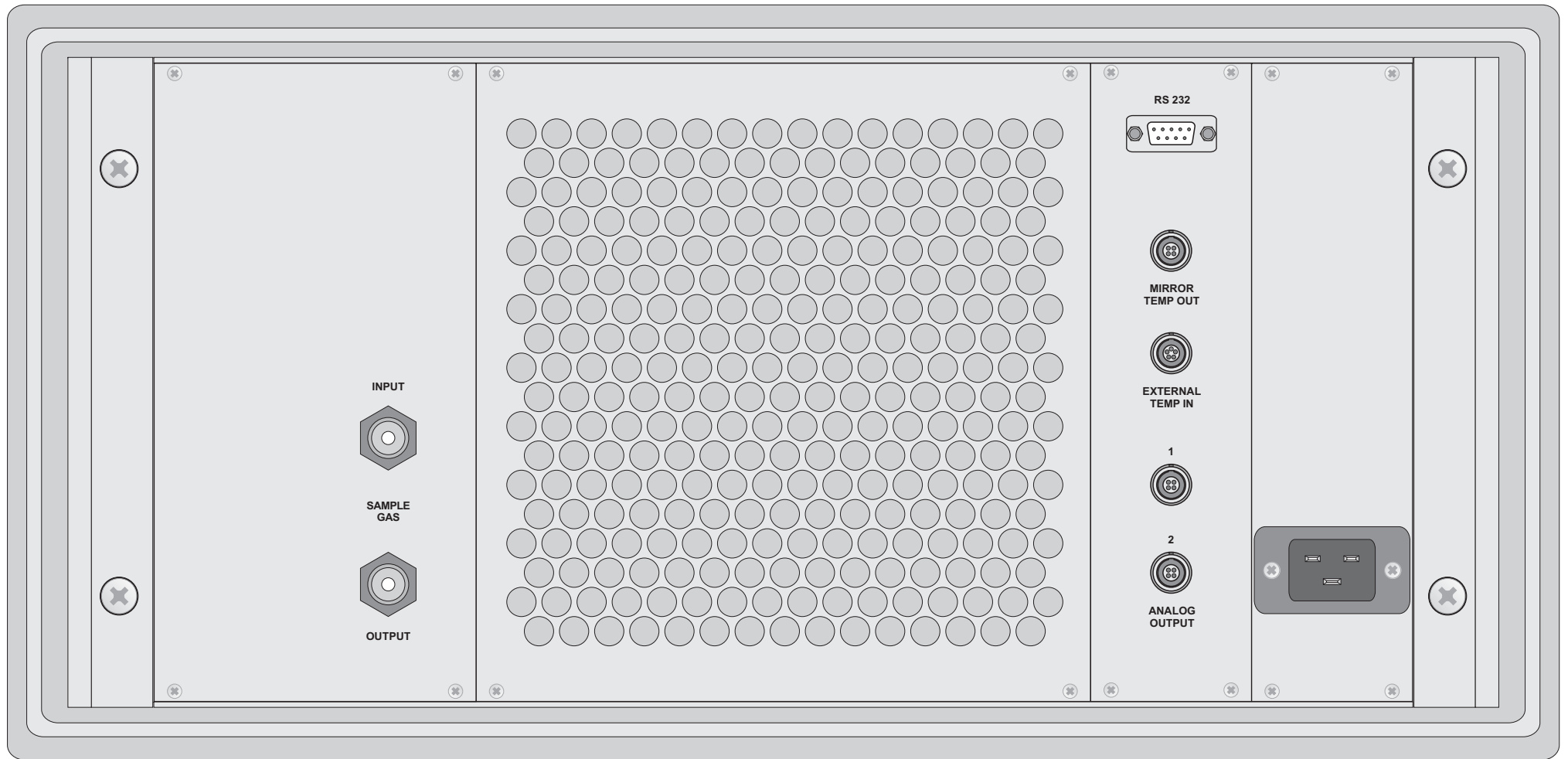

373LX Back Panel						SIZE	A4		
						SHEET	1/1		
DOC NO.	373LX BP Form	DRAWN	DM/gh	SCALE	NO	REV	1.5		DATE

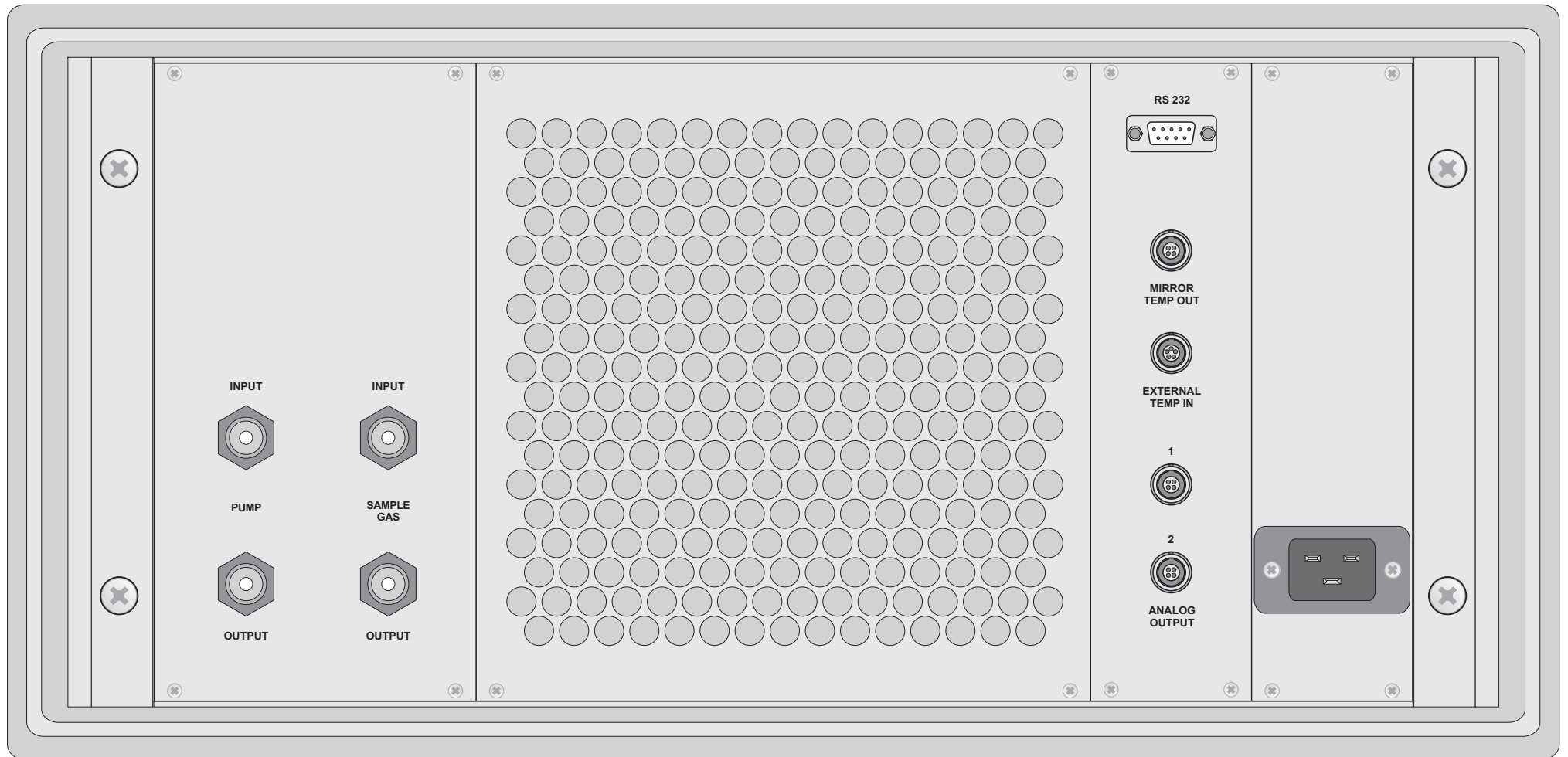

373LX Back Panel with Pump							SIZE	A4	
							SHEET	1/1	
DOC NO.	373LX BP Form	DRAWN	DM/gh	SCALE	NO	REV	1.3	DATE	

Dew Point Mirror 373

MBW calibration
-
-
-

9.50	Relative Humidity %	
24.693	External Temp. °C	
-8.530	Frost Point °C	
-9.592	Dew Point °C	
-9.56 °C	Dew Point	
-9.66	Time Span 20.16.30	
Balance Indicator + - STABLE	Frost Density Hi 0	Mirror Residue Hi 0
Water Cooling	Heater	Pump
Mirror Check	Mirror Cleaning	Dew/Frost Control

7	8	9
4	5	6
1	2	3
0	.	exp
+/-	enter	

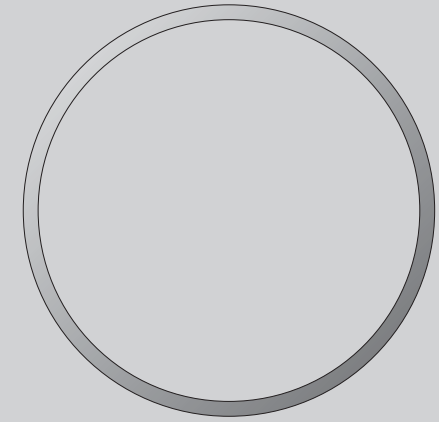

373S Front Panel						SIZE	A4		
						SHEET	1/1		
DOC NO.	373S fp form	DRAWN	DM/gh	SCALE	NO	REV	1.1	DATE	June 29, 2009

MBW calibration
-
-
-

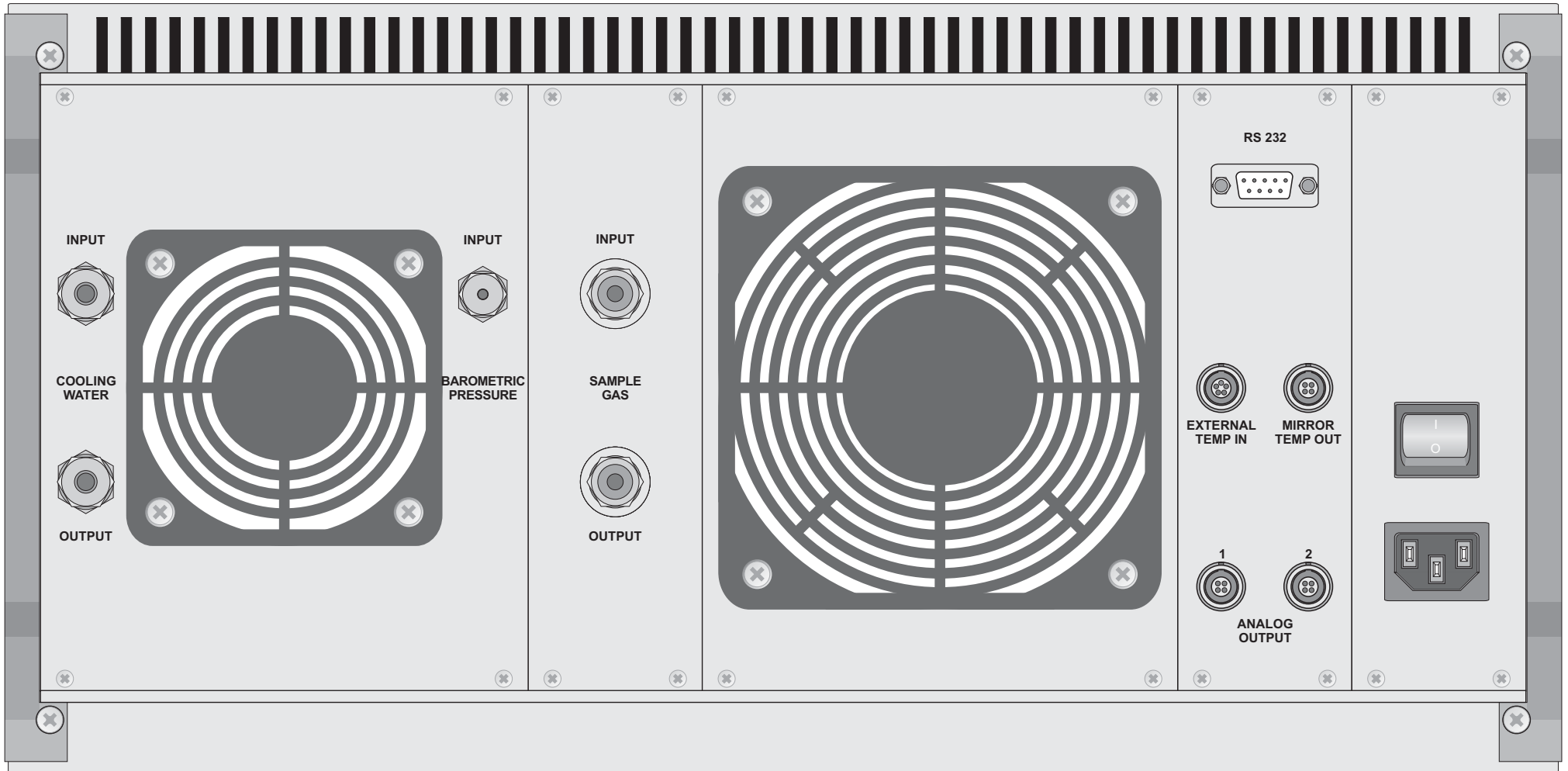

373S Back Panel							SIZE	A4	
							SHEET	1/1	
DOC NO.	373S bp form	DRAWN	DM/gh	SCALE	NO	REV	1.1	DATE	September 27, 2010

