

Catalysis

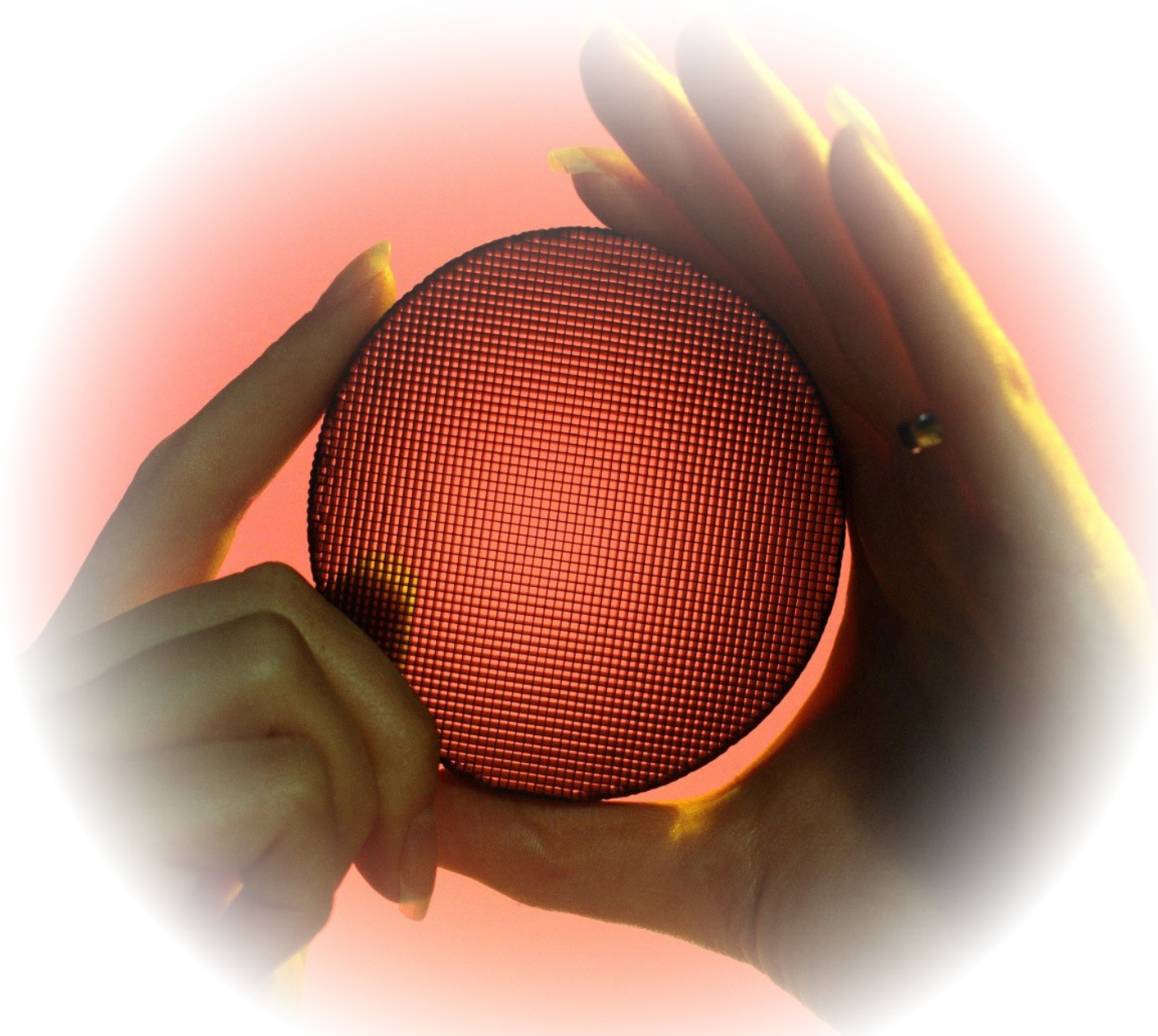

CAPABILITIES



Contents

Extrel instruments have been recognized for their exceptional performance by the world's leading researchers for more than 50 years. Reliability and flexibility are complemented by the most comprehensive application, technical and on-site support in the industry. Our analytical components, instruments and systems for catalysis development address research areas ranging from ultra-fast, ultra-high vacuum desorption studies to the quantification of reaction gas products in real time.

TPD/R/O Research Gas Analysis	page 1
Thermal Analysis Mass Spectrometry	page 2
Laboratory Gas Analysis	page 3
UHV Temperature Programmed Desorption	page 4
Cluster Size Selection & Deposition	page 5
Transient Kinetic Analysis	page 6
Molecular Beam Sampling	page 7

TPD/R/O Research Gas Analysis

Extrel's range of benchtop gas analyzers feature application specific capillary sampling interfaces for coupling to existing microreactors and with mass range options from 2-100 amu or 2-300 amu and detection limit of 500 ppb.

System configurations are available to match a wide range of reactor designs and experimental conditions. Options such as dedicated bypass and high compression downstream pumping are available for rapid clearing of the sampling capillary and optimization for light carrier gases.

Full spectrum survey scanning is complimented by multiple species detection in real-time. External start/stop signals control data collection and temperature which can be synchronized.



MAX300-CAT Laboratory Gas Analyzer

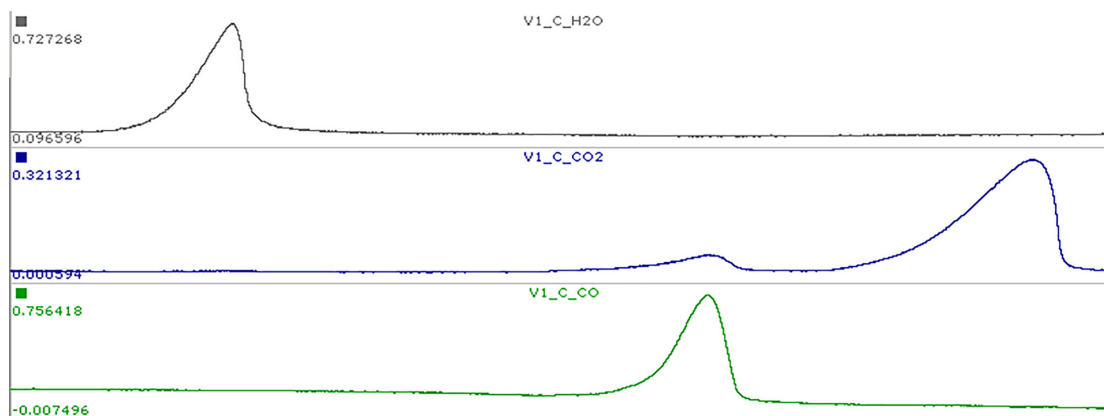

Dynamic Quantitative Gas Analysis

- Application specific interfacing to existing microreactors
- Mass ranges from 2-100 amu or 2-300 amu
- Light carrier gas optimization
- Fast clearing capillary inlet (<300 msec response)
- Synchronized with temperature ramp
- 1,000 data points/sec
- Multiselector valve

Thermal Analysis Mass Spectrometry

The MAX300-EGA is a quadrupole mass spectrometer optimized for evolved gas analysis in a laboratory setting.

The MAX300-EGA has the capability of scanning from 1-500 amu. It also features the Extrel 19 mm mass filter which delivers high analytical repeatability and long term stability. The Questor® 5 process control software allows the system to perform qualitative analysis for sample characterization, or quantitative analysis, measuring concentrations from 100% down to 10 ppb.

In addition to the transfer line, a MAX300-EGA is equipped to import a start-of-heating signal from the TGA. This feature can be configured to perform calculations and trend data, or output the data for viewing and manipulation on a different platform.

- Up to 500 amu mass range
- 10 ppb detection limit
- Optimized for evolved gas analysis from TGA equipment
- Re-entrant inert inlet for maximum interpretation of evolved species
- Identification of high mass decomposition products



MAX300-EGA Evolved Gas Analyzer

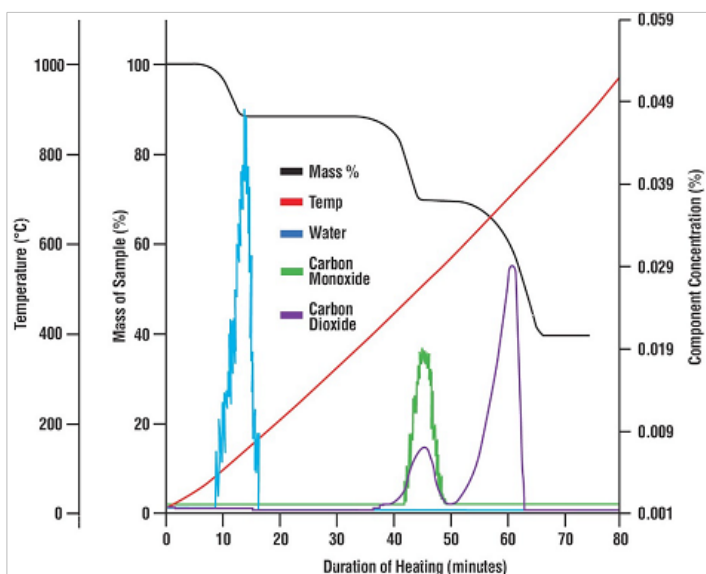

Qualitative and Quantitative Analysis of TGA Evolved Gas

Laboratory Gas Analysis

The MAX300-LG, Laboratory Gas Analyzer, packages the analytical capabilities of our high performance Industrial Mass Spectrometer for the laboratory.

This analyzer provides Extrel quadrupole performance in an economical package suitable for catalysis research, bench scale reactors, process development and pilot scale research.

A unique feature of the MAX300-LG is the ability to provide true quantitative analysis of complex gas mixtures. The Questor® 5 software utilizes multivariate techniques, allowing the monitoring of an unlimited number of components with an analytical precision of +/-0.0025% (on 1% argon signal) and 30 day stability of just +/-0.005%.

The user has the option of single ion monitoring or full mass range scanning. Component concentrations, intensities and derived (calculated) values are displayed, stored and output as defined by the user. Display options include graphical and tabular displays for both real time and archived data. The system performs extensive diagnostics during SmartStart™ and continuously monitors diagnostics during operation to ensure data validity.

- Up to 500 amu mass range
- 10 ppb detection limit
- Fully automated quantitative output
- >180 compound spectral library
- Web server interface

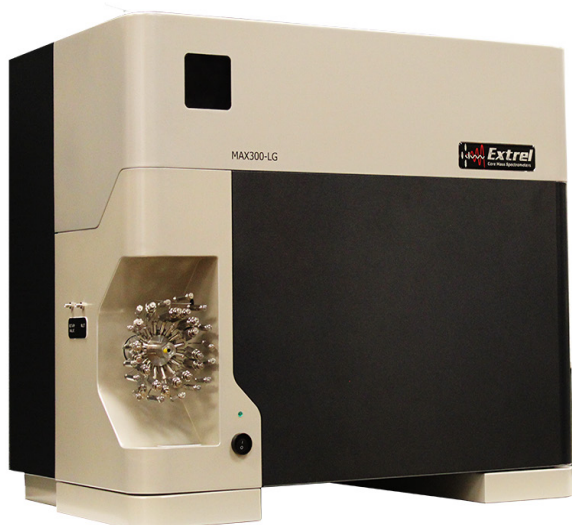

MAX300-LG High Performance Laboratory Gas Analyzer

Fragment Matrix		Sensitivity	Relative Abundance					
Add Chemicals			m/z 18	m/z 28	m/z 32	m/z 40	m/z 44	m/z 84
<input checked="" type="checkbox"/>	H2O	.908	100					
<input checked="" type="checkbox"/>	N2	1.000		100				
<input checked="" type="checkbox"/>	O2	.915			100			
<input checked="" type="checkbox"/>	AR	1.356				100		
<input checked="" type="checkbox"/>	CO2	1.553		11			100	
<input checked="" type="checkbox"/>	KR	1.000						100
Background intensity:			.000000	.000000	.000000	.000000	.000000	.000000
Detector:			Farad	Farad	Farad	Farad	Farad	Mult
Ion Repeat:			1	1	1	1	5	1

Quantitative Gas Analysis Analytical Method

UHV Temperature Programmed Desorption

The MAX-Series UHV TPD mass spectrometers are fully configured UHV compatible quadrupoles that can be incorporated directly into existing UHV systems.

Unrivalled sensitivity of the MAX-Series instruments allow for detection of partial pressures at the 10^{-16} mbar level, with both axial and right angle sampling options to suit chamber geometry.

The MAX-Series probes also feature user selectable combinations of analog or digital detection with mass range options to 4000 amu.

- High sensitivity up to 6 mA/Torr
- High resolution $M/\Delta M=3000$ at m/z 28
- Partial pressure detectability to 10^{-16} mbar
- High abundance sensitivity to 10^7
- Mass ranges from 1-60 to 4-4000 amu
- Positive and negative ion detection
- Ability to monitor an unlimited number of masses
- Ability to synchronize temperature and pressure data with mass data

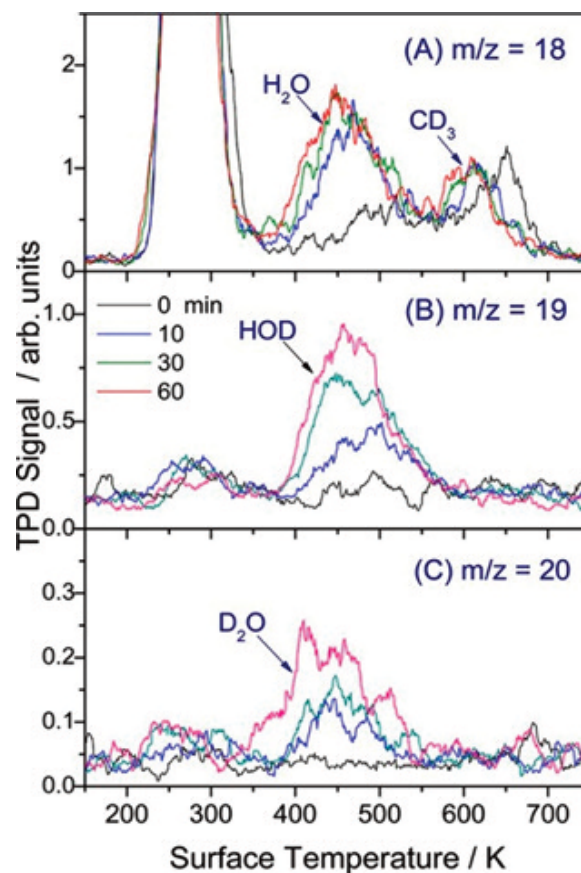

Temperature Programmed Desorption Example

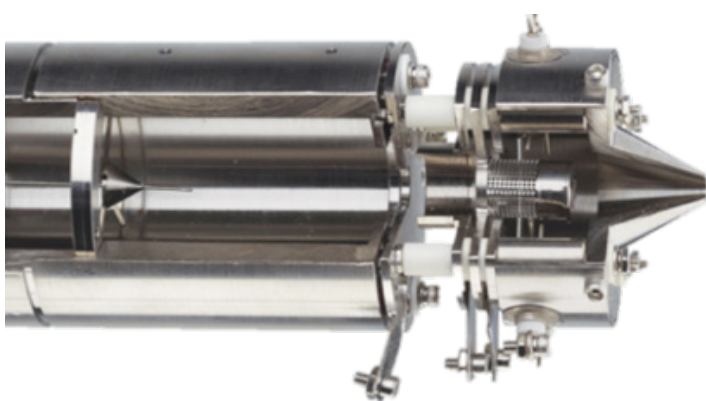

MAX Series Probe

Cluster Size Selection & Deposition

We have been supplying quadrupole mass filters, ion guides, deflectors and ion optics to the clusters research community for more than 30 years.

In addition to offering individual components for a 'building block' approach to system development, we also design and develop turnkey systems for dedicated clusters research.

Our products in this area include quadrupole mass filters with mass ranges as high as 16,000 amu and with resolution sufficient enough to separate single atom differences in clusters for atoms larger than 20 amu.

In addition, Extrel's ion guides and ion optics, along with expertise in vacuum technology, can be applied to the solution of ion transport and pressure reduction from any type of ion source.

- Clusters up to 16,000 amu
- Sampling apertures
- Quadrupole mass filters
- Einzel lenses
- Multipole ion guides
- Quadrupole deflectors
- Gas tight housings

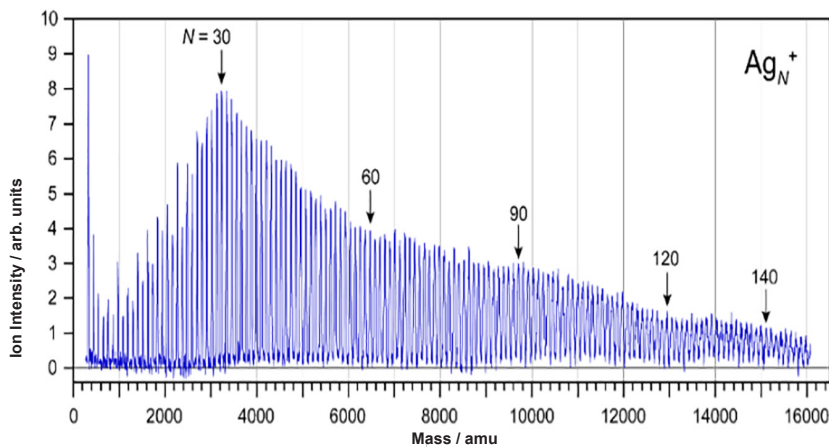

Silver Cluster Ions to 16,000 Daltons

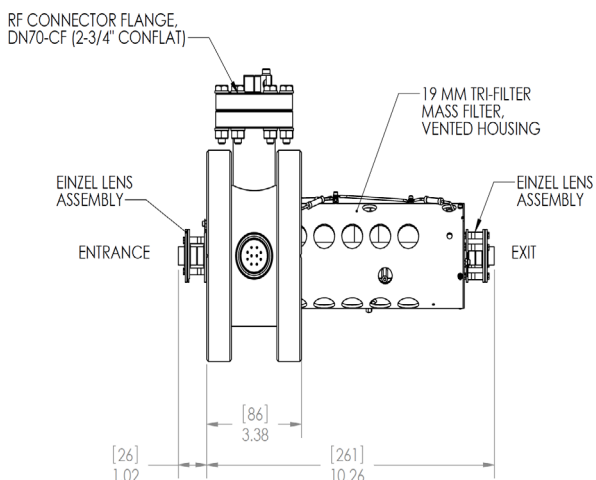

Flow Through Cluster Size Selection Mass Filter with Ion Optics



Cluster Deposition System

Transient Kinetic Analysis

Transient kinetic analysis can provide detailed information of reaction intermediates and reaction sequence.

The MAX-LT mass spectrometer is a compact, high sensitivity tri-filter quadrupole MS system which is ideally suited to steady state isotopic transient kinetic analysis. The instrument offers ultra-fast digital detection, achieving measurement speed up to 10,000 data points/sec.

Data acquisition is synchronized with gas pulse valves via the on-board input/output channels from the spectrometer control system.

Both axial and cross beam sampling arrangements are available. The compact form of the analyzer allows for easy integration into existing apparatus.

- 10,000 measurements/second
- Ion counting digital detector
- Synchronized with external pulse valves
- Up to 1,000 amu mass range (extended to 4,000 with MAX series probe)
- Ability to monitor an unlimited number of masses

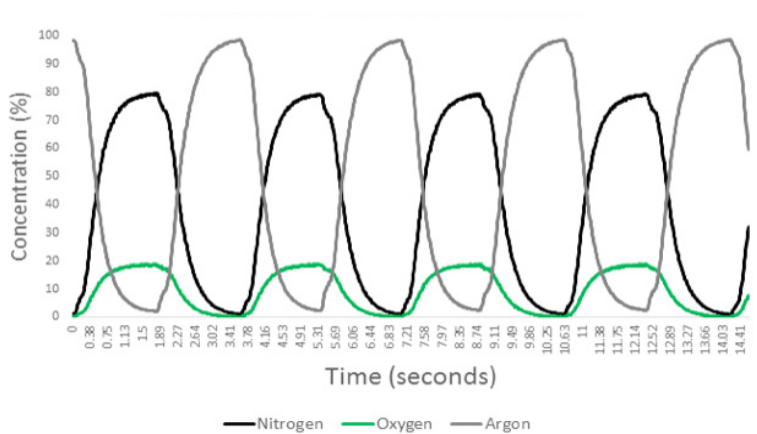

Transient Kinetic Analysis Example



MAX-LT Flange Mounted RGA MS

Molecular Beam Sampling

Molecular beam sampling opens up the possibility of detailed measurement of reactive gas species from a wide pressure range. Collisionless transfer of reactive species requires careful design of the mass spectrometer sampling system. Extrel are pioneers of molecular beam sampling, right up to the present day VeraSpec MB analyzer.



VeraSpec Molecular Beam Mass Spectrometry System

The VeraSpec MB systems utilizes the unique cross-beam sampling configuration which significantly improves signal-to-noise over axial sampling arrangements. The Cross Beam Deflector Ionizer deflects the ionized gas phase species through 90°, separating them from photons, metastables, particulates and molecular beam gases. Filtering out photons and high-energy ions in this way removes spurious background signal and maintains the integrity of the quadrupole mass filter, allowing potentially harmful deposits to pass straight through and on to the ultra-high vacuum pumping system.

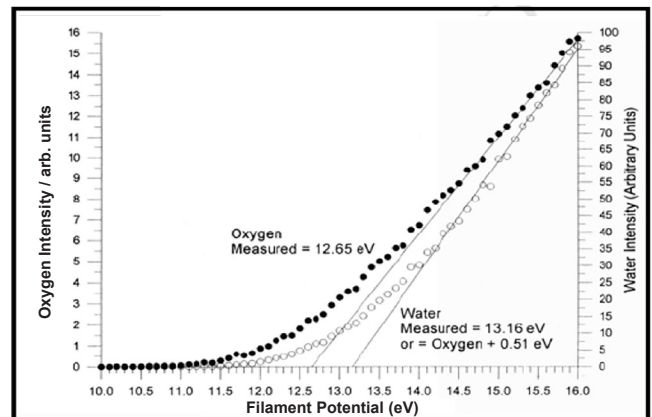

Appearance Potential Data

- Multi-stage skimmer inlet design
- Cross beam sampling for highest signal to noise
- Integrated beam chopper for highest sensitivity
- Mass ranges from 1-60 to 4-4000 amu
- Detection of reactive species via threshold ionization
- Quadrupole deflectors
- Gas tight housings

Application Area and Product Matrix

Products



MAX300-CAT



MAX300-LG/EGA



MAX Probe System



Quad/QC/Optics

Application Area

Nano Structures

Catalyst Materials

Reaction Kinetics

Catalytic Reaction Monitoring

Process Control

		SIMS surface analysis TPD surface analysis reaction monitoring in vacuum (sensitivity)	Size selection (selectivity, transmission, stability) Soft landing (low ion energy (<1eV) at landing)
		SIMS, TPD	
	Reaction gas analysis	Reaction gas analysis (sensitivity, speed)	Crossed molecular beam
	Gas analysis	Gas analysis	
	Gas analysis	Gas analysis	

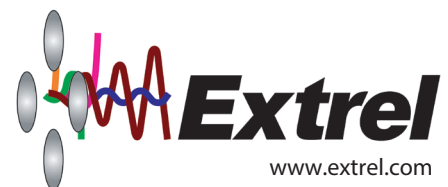

www.extrel.com
412-963-7530

©2018 Extrel CMS, LLC. Extrel is a registered trademark of Extrel CMS, LLC.

Questor 5 is a registered trademark of Extrel CMS, LLC.

RCC100A