

PRODUCT USER MANUAL

LPDT2

Loop-Powered Dew Point Transmitter

NEW



Display version



No display version

Reliable and Fast

Cost-Effective

Low Maintenance

Monitoring and control for:

- Air dryers
- Plastic dryers
- Glove boxes
- Welding gases
- Clean room environments

This equipment, where applicable, has been manufactured in accordance with the standards listed below. Please contact the factory for the exact applicability of your model.

IECEX Document OD 17 Drawing and Documentation Guidance

Explosive Atmospheres – Part 0: Equipment – General Requirements
[IEC 60079-0:2017 Ed.7]

Explosive Atmospheres – Part 0: Equipment – General Requirements
[EN IEC 60079-0:2018]

Explosive Atmospheres – Part 0: Equipment – General Requirements
[UL 60079-0:2019 Ed.7]

Explosive Atmospheres – Part 0: Equipment – General Requirements
[CSA C22.2#60079-0:2019 Ed.4]

Explosive Atmospheres – Part 11: Equipment Protection By Intrinsic Safety "i"
[IEC 60079-11:2011 Ed.6]

Explosive Atmospheres – Part 11: Equipment Protection By Intrinsic Safety "i"
[EN 60079-11:2012]

Explosive Atmospheres – Part 11: Equipment Protection By Intrinsic Safety "i"
[EN 60079-11:2013 Ed.6+R:14Sep2018]

Explosive Atmospheres – Part 11: Equipment Protection By Intrinsic Safety "i"
(R2018) [CSA C22.2#60079-11:2014 Ed.2]

Electrical Equipment for Measurement, Control, and Laboratory Use; Part 1: General Requirements
[UL 61010-1-2012 Ed.3+R:19Jul2019]

Safety Requirements for Electrical Equipment for Measurement, Control, and Laboratory Use
Part 1: General Requirements
[CSA C22.2#61010-1-12:2012 Ed.3+U1:U2;A1]

When calling your representative for technical support, please have your serial numbers available. The Sensor and Instrument Serial Numbers are on the instrument.

COSA Xentaur
4140 World Houston Parkway Suite 180
Houston, TX 77032, USA
+1 713 947 9591

Except as may be provided by contract, this document and all specifications and drawings contained are the property of COSA Xentaur and/or Process Insights issued in strict confidence, and shall not be reproduced or copied or transmitted, in any form or by any means, or used as the basis for the manufacture or sale of apparatus, programs, or services without permission.

Check the Internet for updates; the latest revision of this manual is available in Adobe Acrobat format at: <https://www.process-insights.com/>

Document No.: LD1.01.D.1000 Rev 0 02/21/2021

Document No.: LD1.01.D.1000 Rev 1 04/08/2022

Document No.: LD1.01.D.1000 Rev 2.5 06/08/2022

Document No.: LD1.01.D.1000 Rev 3.0 12/08/2022

Document No.: LD1.01.D.1000-GP Rev 3.1 06/16/2023

Copyright © 2023 by COSA Xentaur Corporation

COSA Xentaur and/or Process Insights reserves the right to change or modify the product specification and / or appearance at any time without notice. Therefore, the information in this document is subject to change without notice and does not represent a commitment on the part of COSA Xentaur Corporation.

The customer agrees that in accepting and using this instrument COSA Xentaur's liability arising from or in any way connected with this instrument shall be limited exclusively to performing a new calibration or replacement or repair of the instrument or sensor, at COSA Xentaur's sole option, as covered by our warranty. In no event shall COSA Xentaur be liable for any incidental, consequential or special damages of any kind or nature whatsoever, including but not limited to lost profits arising from or in any way connected with this instrument or items hereunder, whether alleged to arise from breach of contract, express or implied warranty, or in tort, including without limitation, negligence, failure to warn or strict liability.

Examine the LPDT2 package for damage or mishandling. If any damage is evident notify the carrier and request an inspection.

Unpack the box, it should contain: The LPDT2 with sensor in desiccant container, power/control cable, and this manual.

PLEASE READ THIS MANUAL IN WHOLE, PRIOR TO INSTALLING OR REMOVING THE SENSOR FROM ITS SHIPPING CONTAINER.

This manual is organized in three sections:

- Section 1 is an overview of the LPDT2.
- Section 2 describes the sensor and sampling techniques.
- Section 3 describes the instrument's electrical, mechanical, and user interfaces.

This manual is intended for those already familiar with the installation, use and maintenance of analytical or process instrumentation.

Those acquainted with other COSA Xentaur dew point measurement products such as the XDT or the XPDM, will benefit from the commonality of the user interface.

- Swagelok, Cajon are trademarks of SWAGELOK Co. Acrobat is a trademark of Adobe Systems Incorporated
- Microsoft Windows is a registered trademark of Microsoft Corporation
- HTF is a trademark of COSA Xentaur Corporation and Process Insights
- SpanCheck is a trademark of COSA Xentaur Corporation and Process Insights
- COSA Xentaur Logo is a trademark of COSA Xentaur Corporation and Process Insights



Warning - Potential electrostatic discharging hazard - see instructions

Avertissement - Risque potentiel de charge electrostatique - voir les instructions

SUITABLE FOR SERVICING ONLY WHEN DE-ENERGIZED

PEUT FAIRE L'OBJET D'UN ENTRETIEN UNIQUEMENT

Warranty

COSA Xentaur instruments are warranted to be free from defects in workmanship and materials. Liability under this warranty is limited to servicing, calibrating, and replacing any defective parts of the instrument returned to the factory for that purpose. Fuses are specifically excluded from any liability. This warranty is effective from the date of delivery to the original purchaser. The equipment must be determined by COSA Xentaur to have been defective for the warranty to be valid. This warranty applies as follows:

- one year for electronics
- one year for mechanical failures to the sensor
- six months for calibrations

If damage is determined to have been caused by misuse or abnormal conditions of operation, the owner will be notified and repairs will be billed at standard rates after approval.

Maintenance Policy

In cases when equipment fault is suspected, please notify your representative of the problem, be sure to provide them with model and serial numbers. If the problem can not be resolved, then ask for a Return Material Authorization (RMA) and shipping instructions. Issuance of an RMA does not automatically imply that the equipment is covered by our warranty, that will be determined after we receive the equipment. Pack the equipment in a suitable box (sensor must be shipped with factory provided desiccant bottle) with sufficient padding, include the RMA number on your paperwork, and send the equipment, prepaid, to the designated address.

COSA Xentaur will not accept equipment returned without an RMA or with reversed shipping or import/export charges. If the warranty has expired, or the damage is due to improper use or exposure of the equipment; then COSA Xentaur will provide an estimate and wait for approval before commencing repairs.

TABLE OF CONTENTS

	Page
1.0 OVERVIEW OF THE LPDT2	7
2.1 PRECAUTIONS USING THE SENSOR	7
2.2 TECHNICAL SPECIFICATIONS	8
2.3 SENSOR INSTALLATION & SAMPLING TECHNIQUES	10
2.3.1 In situ Installation	
2.3.2 Extractive Installation	
2.4 TROUBLESHOOTING UNEXPECTED READINGS	13
3.1 PRECAUTIONS USING THE LPDT2	15
3.1.1 Electromagnetic Compatibility Considerations	
3.2 INSTRUMENT TECHNICAL SPECIFICATIONS	16
3.3 INSTALLATION	17
3.4 OPERATING THE INSTRUMENT	17
3.4.1 Starting up	
3.4.2 Operation	
Appendix A: User Interface flowchart	19
Appendix B: Operating State flowchart	22
Appendix C: Set-Up State flowchart	23
Appendix D: LPDT2 Mechanical Drawing	24
Appendix E: LPDT2 Electrical Connections	25
Appendix F: Current vs. Dew Point	26
Appendix G: Uncertainty in LBS & ppmV calculations	28
Appendix H: Sensor Response Time	29
Appendix I : Certifications – Conformity	30
Appendix J : LPDT Modbus Format	31

1.0 Overview of the LPDT2

NOTE: There are two versions of the LPDT, with Display and a non-Display variant. Whenever references are made to LCD display and/or buttons, the content is referring to the Display variant. Whenever references are made to the 4-20mA and/or Modbus interfaces, the content is referring to either the Display or the non-Display variants. This note should be applied to the balance of the content in this manual from here forward.

The LPDT2 is a microprocessor based 4-20mA loop-powered (2 wire) hygrometer, for measuring moisture content in gases in the range from -100°C to +20°C. The measurement is displayed on the instrument's custom LCD, and is transmitted by varying the current drawn (4-20mA) from the power supply. The current varies linearly proportional to the selected measurement units, in addition there is a Serial MODBUS Interface over RS485 for obtaining additional detailed data and logging. Four front panel buttons provide the user with a wide variety of features. The LPDT's advanced design allows it to be housed in a small stainless steel enclosure connected to the sensor probe, thus the instrument (transmitter) and sensor are a single integrated unit.

The LPDT2 uses the COSA Xentaur HTF™ Al₂O₃ sensor which is encapsulated in 100 sintered stainless steel, thus it is capable of coming into contact with a wide variety of environments. However one should keep in mind that the sensor is a sensitive device and it should be handled accordingly. When not in use, always store in the supplied desiccant bottle.

2.1 Precautions using the sensor

The COSA Xentaur HTF Al₂O₃ sensor is designed and field proven to be highly reliable, rugged and maintenance free. However the user should consider the following precautions:

- To avoid the need for prolonged dry-down (when expecting to measure dew points dryer than -65°C), do not expose the sensor to room air longer than necessary (1 – 2 minutes). Thus, do not open the sensor container before you are ready to install the sensor.
- The sensor container has desiccant to keep the sensor dry during shipping and to avoid damage due to condensation. Close the container immediately after removing the sensor to avoid degradation of the desiccant.
- **Do not throw away the sensor container**, you may use it again to transport the sensor between locations, to store it between uses or to ship it back to the factory for certification. The container can be attached to the loop cable, by trapping the cable with the lid strap.
- Do not expose the sensor to corrosive gases such as gases containing chlorine, ammonia or HCl. (SO₂ can be monitored when the moisture content is low).
- Do not expose the sensor to liquid water, as it may get damaged.
- Do not breathe directly onto the sensor, as condensation may form which could damage the sensor element.
- Do not install the sensor near heat sources such as radiators or air ducts.
- Do not install the sensor in places subject to extreme mechanical vibration or shock. If this is not avoidable, use resilient mounting. If in doubt, call your representative.
- Do not disassemble the porous metal filter encapsulation, as this will damage the sensor and void your factory warranty.
- Prior to installation of the probe, ensure that no contaminants are present in the system (e.g. oil, liquid water).

2.2 Technical Specifications

NOTE: If the equipment is used in a manner not specified by the manufacturer, the protection provided by the equipment may be impaired.

Instrument:

Enclosure:	Stainless Steel, weatherproof (IP66)
Weight & dimensions:	0.5 lbs, ~2" Dia. x ~4.75" long including sensor & connector (see appendix D for actual dimensions)
Pressure operating range:	Standard: 5,000 PSI (340 bar)
Mechanical connections:	$\frac{3}{4}$ "-16 threads and 14mm x 1.25mm threads
Electrical connections:	Device: Molex 1200905081 5pin male connector Mate: Molex 1200860192 5pin female connector
Pinouts:	Pin 1: RS-485-A Pin 2: Power Input (not polarity sensitive) Pin 3: RS-485-B Pin 4: Power Input (not polarity sensitive) Pin 5: Ground
Cable:	Five conductor cable, 12' (~4m) provided.
Power Requirements:	10 to 33 VDC polarity independent, draws 4-20mA (internal non-serviceable fuse rated at 125mA)
Input resolution:	0.1°C dew point
Indicators: Engineering units: Controls:	3.5 digit, alpha-numeric LCD with custom legends °C, °F, ppmV, lbs , g/m ³
Outputs:	4 push buttons (display varaint only), user's selections are stored in EEPROM Analog and digital outputs are available from the LPDT2 <ol style="list-style-type: none">1. The 4-20mA is linear to the selected engineering units, the range is programmable. Output resolution is 0.1°C dewpoint.2. MODBUS interface over RS-485.
Isolation:	Sensor and case are isolated from the current loop but are shunted with a 33V transorb and 2000pF capacitor

Sensor:

Type:	Hyper Thin Film high-capacitance Al ₂ O ₃
Dew Point range:	XTR-100 -148°F to +68°F (-100°C to +20°C) XTR-65 -85°F to +68°F (-65°C to +20°C)
Capacitance:	5nF to 200nF
Accuracy:	±5.5°F (±3°C)
Repeatability:	±0.9°F (±0.5°C)
Response time:	See graph in Appendix J
Temperature range:	-10°C to +70°C
Sample Flow range:	(linear velocity @ 1ATM): Static to 100m/s
Storage temperature:	-40°F to +176°F (-40°C to +80°C)
Mechanical:	Encapsulated in 100μ sintered stainless steel
Calibration method:	SpanCheck™, sensor saturates at dew point above +68°F (+20°C). NIST/ NPL traceable multi-point factory calibration available optionally

Overall Device (Instrument and Sensor):

Environmental:	Temperature -10 to +70 C Humidity up to 95% Overvoltage Category: II Pollution Degree: II
----------------	--

I.S. Parameters (applicable to specific models):

Input power supply: (U_i = 33V, I_i = 66mA, P_i = 544mW, L_i = 16.5uH, C_i = 0F)

RS485 Interface: (U_i = 3.3V, I_i = 1mA, P_i = 3.3mW, L_i = 200mH, C_i = 100pF)

Ex Marking Strings (applicable to specific models):

- a. For IECEx: Ex ic IIC T5 Gc
- b. For ATEX: II 3 G Ex ic IIC T5 Gc
- c. For UKEX: Same as ATEX above
- d. For ETL: Class I, Division 2, Groups A, B, C, D Class I,
Zone 2 AEx ic IIC T5 Gc

2.3 Sensor Installation & Sampling Techniques

Keep in mind that the moisture content at the sensor is not only due to the moisture of the gas being measured, but also due to desorption of water from tubing, trapped moisture (at the interconnection points, valves, filters and other hygroscopic materials in the system), leaks in the system, and others. Thus the measurement may vary from the expectation, and therefore care should be taken in choosing the sampling technique utilized in the measurement. Factors such as gas pressure, flow rate, materials of construction, length and diameter of tubing, number of interconnecting fittings, dead space in tubing and manifolds; will influence the measurement value and response time.

The high capacitance HTF Al_2O_3 sensors can be installed either directly in the line to be sampled (in situ), or in the recommended slip stream of a sample system (extractive).

To assure a long and accurate performance of the sensor, it should be protected from contaminants such as liquids (water, oil etc.), and particulates. The sintered stainless steel sensor encapsulation protects from particulates larger than 100 microns, finer particulates (e.g. from degraded desiccant or rust) should be filtered with a particulate filter with suitable capability, do not use hygroscopic filter materials.

2.3.1 In-situ Installation

In situ installation is recommended only for measurements where the gas pressure is expected to vary little, the gas is expected to be free of contaminants, the gas temperature is within the operating specifications of the sensor, and there is no chance of liquids coalescing. Examples of applications suited for in-situ installations are: pure gases, output of desiccant dryers (for instrument air), glove boxes, etc. For most other applications in-situ installation should be avoided for the following reasons:

- Sample conditioning is almost always necessary to avoid exposure of the sensor to liquid water and other contaminants, such as hydrocarbons, which may damage the sensor or affect accuracy over time.
- Variations in line pressure affect the reading of the sensor because dew point varies with pressure.
- If the gas line is under pressure, it is more likely that water condensation can occur on side of pipe which may damage the sensor.
- Under a pressurized system removal of the sensor without the installation of isolation valves can be dangerous.

Bypass mounting is preferable, if in situ installation is required make sure to install the sensor at 90 degrees at the top of the gas line to minimize its exposure to liquid water.

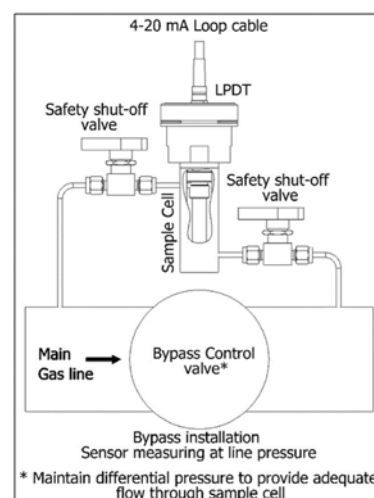
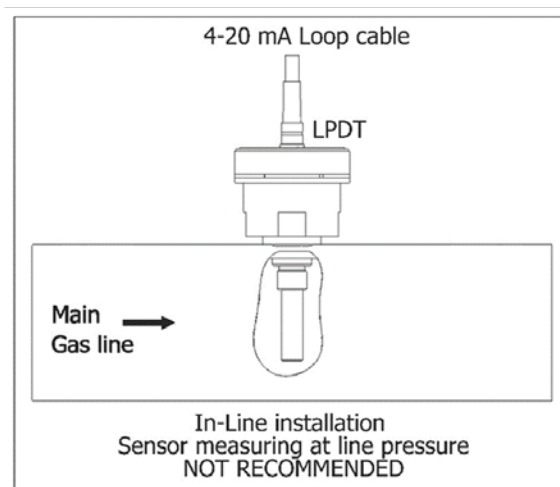

2.3.2 Extractive Installation

For extractive installations we recommend our sample system ESS, which may be equipped with a variety of features, such as: isolation valve, coalescing or particulate filter, pressure regulator, calibration sample injection or extraction port, pressure gauge, flow meter, weatherproof enclosure. Refer to the ESS literature for more information.

If the resources to make your own sample system are available, the following two diagrams may be used as a guideline to configure a simple system.

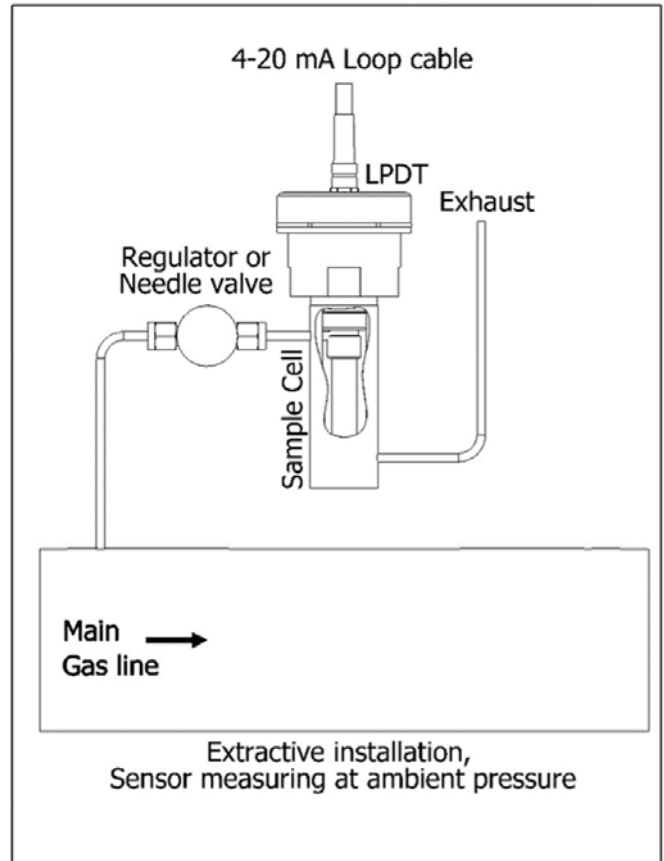
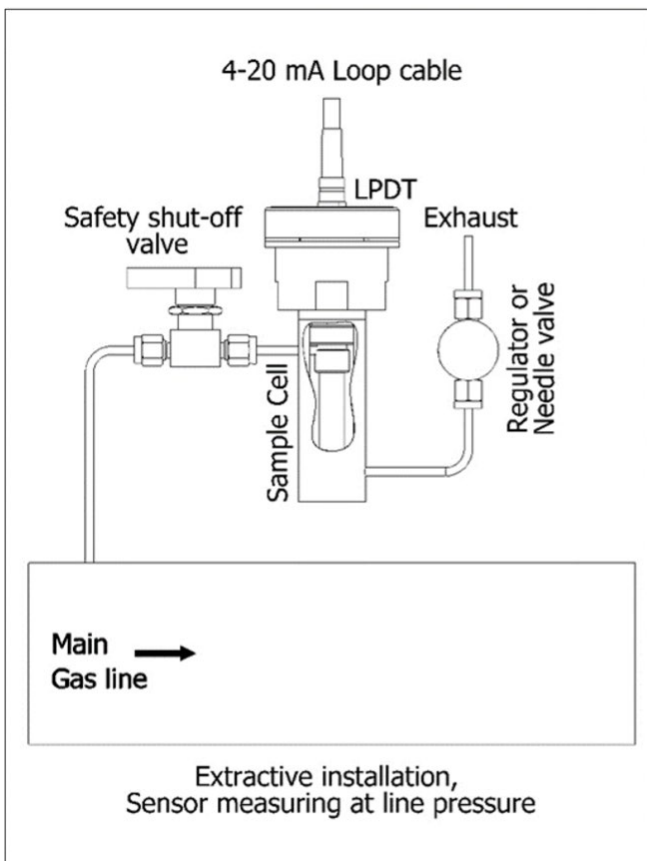

It is generally recommended to measure at ambient pressure for the following reasons:

- The readings will not be affected by variations in line pressure.
- The risk of exposing the sensor to liquid water is significantly reduced.
- ppm readings are computed for a pressure of one atmosphere (1 bar); and have to be corrected using software in the instrument, or a pressure nomograph, or calculator if the sensor is measuring at different pressures.

If readings at line pressure are necessary, it is recommended to measure at ambient pressure and to use the instrument's pressure compensation feature to calculate the dew point at line pressure. See appendix G.

Please make sure that:

- The sample is taken from the upper surface of the main gas line. This avoids problems with contamination. The sample should be taken away from pipe line walls where flow rates may be low, and dew point changes may lag.
- For dew points dryer than -40°F, use stainless steel tubing only. Copper tubing is acceptable for dew points wetter than -40°F. Do not use plastic, rubber or tygon tubing under any circumstances, as measurements would be incorrect and/or response time slow due to water retention inside these materials.
- Try to run pipes to the sensor upwards, so that contaminants tend to fall back into the main line.
- Keep the length of the sample line to the sensor as short as possible.
- Use small diameter pipes (1/4" or 1/8" OD).
- Use sufficient flow rates (e.g. 1 l/min with 6 feet of 1/8" piping is adequate). The flow rate will influence the systems' response time.
- Do not install any devices upstream of the sensor, such as other measuring systems, flow meters etc., which are not absolutely necessary as these are potential leak sources.
- Installation of a coalescing and / or particulate filter ahead of the sensor is desirable to prevent any liquid or particulate contamination of the sensor.
- If filters are used upstream of the sensor, make sure these contain non-hygroscopic filter materials only.
- If pressure regulators, shut off valves etc. are used upstream of the sensor, make sure these do not contain rubber or other hygroscopic materials.

2.4 Troubleshooting unexpected readings

If erroneous readings are suspected on a newly acquired instrument, compare the serial number engraved on the sensor sintered filter, to the one stored in the instrument memory. The two should be the same; if they are not, the instrument may not be calibrated with the installed sensor. To troubleshoot other problems, identify the unexpected reading category in the following table, and consider the possible causes and appropriate diagnostic action and remedy.

Troubleshooting unexpected readings

Symptom	Possible Cause
Reading is not changing	Condensation in sample system.
Slow Response	<ol style="list-style-type: none">1. Water vapor in the system.2. Flow rate too low.3. Sample pipe too large and/or too long.4. Unsuitable sample pipe material.5. Leaks6. Hygroscopic materials in sample system
Dry Reading	SpanCheck™ wrongly set, or faulty sensor.
Wet Reading	Leak in system or use of unsuitable pipe.
	Comparison of readings with manual cooled-mirror instrument.
	Prolonged exposure to wet gas.

For non-sensor related problems (e.g. no reading on instrument) refer to section 3.5

Troubleshooting unexpected readings (continued from previous page)

Symptom	Diagnostic/Remedy
Reading is not changing	Condensation will occur if the temperature of the sample system, at any point is below (colder) the dew point temperature of the sample gas. Once having formed, the sample reaching the sensor will have a dew point equal to the temperature of the condensation, regardless of the dew point of the sample at the sample point.
Slow Response	It is usually more satisfactory to bleed a sample gas at atmospheric pressure through the sensor sampling chamber, and to use 1/8" (3mm) o.d. sample pipe. See below re: sample pipe material, also see section 2.3
Dry Reading	Verify SpanCheck™, or return sensor for full calibration to your representative.
Wet Reading	Cure the leak, or replace unsuitable pipe with copper or stainless steel. Flexible connections should be made with PTFE pipe. NEVER use rubber or plastic pipe.
	This type of indicator reads about 10°C dry at about -50°C dew point due to temperature gradients within the device. The error increases at drier levels.

3.0 Precautions using the LPDT2

The LPDT2 uses state-of-the-art microelectronics to provide a miniature full functioning instrument. The user should consider the following precautions when using any sensitive electronic device.

- Do not install the unit near heat sources such as radiators or air ducts.
- Do not install the unit in places subject to extreme mechanical vibration or shock. If this is not avoidable, use resilient mounting. If in doubt, call your representative.
- Observe the appropriate electrical safety codes and regulations
- If weather-proofing is required consult your representative for an optional cover.

3.0.1 Electromagnetic Compatibility Considerations

The LPDT2 has been designed and verified by testing to meet the requirements of the EC Council EMC Directive, please see the list of applicable standards at the beginning of this document. The sensor ground (LPDT2 housing) is isolated from the 4-20mA loop, however they are also shunted with a 2000pF capacitor and a 33V Transient Voltage Suppressor; this prevents electrostatic buildup, noise pick-up, and in conjunction with the internal fuse protects the instrument from over-voltage inputs. Please consider the following electromagnetic interference issues during installation:

- In order to provide an acceptable noise environment for the LPDT2 or any other digital equipment in the proximity of inductive loads, it is recommended that there be varistors placed across the inductors to keep down the high voltage spikes during transitions.
- Any circuitry which is activated by relay contacts should account for the contact bounce, one simple de-bouncing method is placing a capacitor across the relay contacts.
- AC power wiring should be routed as far away from the LPDT2 and its wiring as practical.

3.2 Instrument Technical Specifications

Enclosure:	Stainless Steel, weatherproof (IP66)
Dimensions & Weight:	~2" Dia. x ~4.75" long including sensor & connector (see appendix D) 0.5lbs.
Pressure operating range:	Standard.....5,000 PSI (340 bar).
Mechanical connections:	¾"-16 threads 14mm x 1.25mm threads.
Electrical connections:	Device: Molex 1200905081 5pin male connector Mate: Molex 1200860192 5pin female connector
Cable:	Pin 1: RS-485-A Pin 2: 4-20 mA loop Power Input (not polarity sensitive) Pin 3: RS-485-B Pin 4: 4-20 mA loop Power Input (not polarity sensitive) Pin 5: Ground Five conductor cable, 12' (~4m) provided.
Power Requirements:	10 to 33 VDC polarity independent, the instrument draws 4-20mA depending on measured dew point.
Input resolution:	0.1°C dew point.
Indicators:	3.5 digit, alpha-numeric LCD with custom legends.
Engineering units:	°C, °F, ppmV, lbs , g/m3.
Controls:	4 push buttons, user's selections are stored in EEPROM.
Outputs:	Analog and digital outputs are available from the LPDT2. 1. 4-20mA drawn by the instrument from the power supply. The 4-20mA is linear to the selected engineering units, the range is programmable. Output resolution is 0.1°C dew point. 2. The instrument also employs a MODBUS interface over RS-485.
Alarms:	The 4-20mA signal or the digital output may be used by an external device to operate relays.
Isolation:	Sensor and case are isolated from the current loop but are shunted with a 33V transorb and 2000pF capacitor.

3.3: Installation

The LPDT2 will operate properly with 10VDC to 33VDC at its input, if this voltage is exceeded the internal fuse may blow. When selecting the power supply voltage do not neglect the drop across any current measurement resistor and wiring in the loop. The connector is a Molex 1200905081 5pin male connector, an internal diode bridge accommodates either polarity. The LPDT2 may be powered from a power supply using the provided connected cable. The provided cable is terminated with a connector which has a retainer, the retainer may be used to secure the connector to the LPDT2 thus avoiding accidental disconnection.

Pin 1: RS-485-A

Pin 2: 4-20 mA loop Power Input (not polarity sensitive)

Pin 3: RS-485-B

Pin 4: 4-20 mA loop Power Input (not polarity sensitive)

Pin 5: Ground

The LPDT2 will draw 4mA to 20mA from the power supply depending on the dew point being measured. The dew points corresponding to 4mA and to 20mA are user selectable, in between the current will vary linearly to the selected engineering units, see appendix H. Various strategies for interfacing with the LPDT2 are shown in Appendix E.

Please observe good electrical safety and grounding practices when connecting any electrical equipment; connecting one end (e.g. negative) of the power supply to earth ground is advisable. After the installation is complete, proper detection by the user's equipment of the 4-20mA output, may be tested using the Analog Output test feature of the LPDT2.

3.4 Operating the Instrument

3.4.1 Starting up

The instrument is ready for use as soon as the power is applied via the power/control. The instrument after initializing it will enter the Operating State. If the MODE button is held pressed while the instrument is powering-up, it will enter the Set-Up State, which allows the user to select operating variables of the instrument. To accommodate a variety of installation possibilities, the LPDT2 front panel may be rotated (upto 360°) by turning it to the desired position*.

*The face rotation feature is intended to align the display for easy readability, it should not be repeatedly rotated as this could cause unseating snap ring.

3.4.2 Operation

*Applies to display variant only

The LPDT2 Menu System can be broken down to three major categories, 1) System Info, 2) Unit Setup, & 3) Calibrations. Below are the required key press sequences to get to the specific function. Example: to read the Sensor Serial number you would press the “↶” key three times in succession.

In most cases the “+/-” keys choose an option that you select. Example: to select the 12mA Analog Output Test, you would press the “↶, ↶, √, ↶, ↶” sequence and you would be presented the 4mA selection. To get to the 12mA setting you would press the “+” key to advance to 12mA. If you continue to press the “+” key, you would be at the 20mA selection.(4mA, 12mA, 20mA, 4mA.....etc.)

NOTE: All keypress sequences start from the Primary Display Mode, where the requested parameter(s) are displayed in the upper right of the display. In most cases pressing the ‘√’ key before the series is complete, cancels the function and returns the operator to the Primary Display Mode.

- 1) System Info
 - a. Unit Serial No. ↶, ↶
 - b. Sensor Serial No. ↶, ↶, ↶
 - c. Firmware Version ↶, ↶, ↶, ↶
- 2) Unit Setup
 - a. Alternate Display Units ↶, ↶, √, +/-, √
 - b. Sensor Type ↶, ↶, √, ↶, +/-, √
 - c. Output Span ↶, ↶, √, ↶, ↶, √
 - d. Analog Output Test ↶, ↶, √, ↶, ↶, ↶, +/-, √
 - e. Analog Output Limits ↶, ↶, √, ↶, ↶, ↶, ↶, +/- (low limit), ↶, +/- (hi limit), √
 - f. Lock/Unlock ↶, ↶, √, ↶, ↶, ↶, ↶, ↶, +/- (lock/unlock), √
- 3) Calibration
 - a. Single Point ↶, -, ↶, ↶, (+/- to specify Ref Gas), ↶, ↶, 60sec timeout
 - b. Span Check ↶, +, +, (must get to +20C), +, 120sec timeout

Appendix A: User Interface flowchart

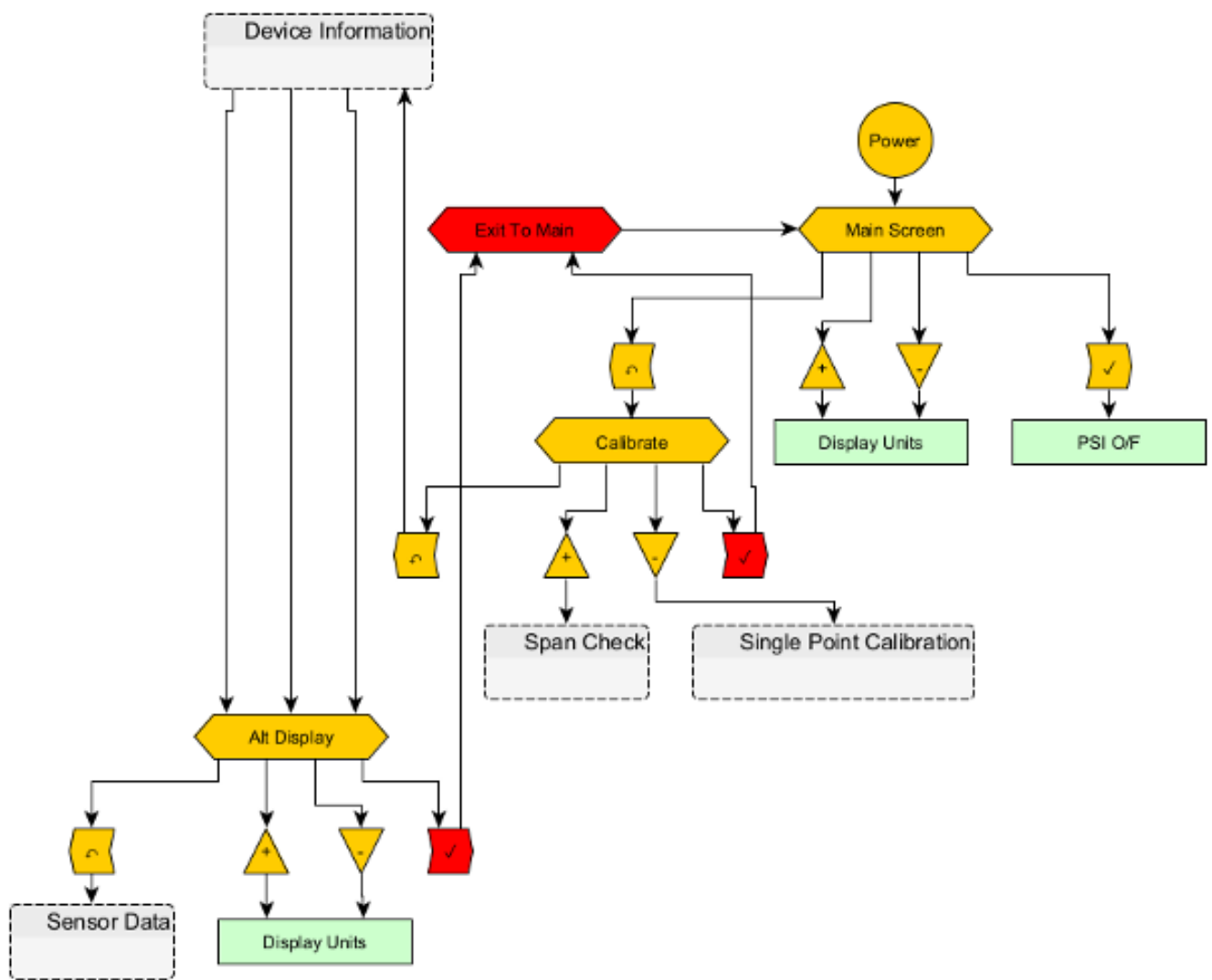

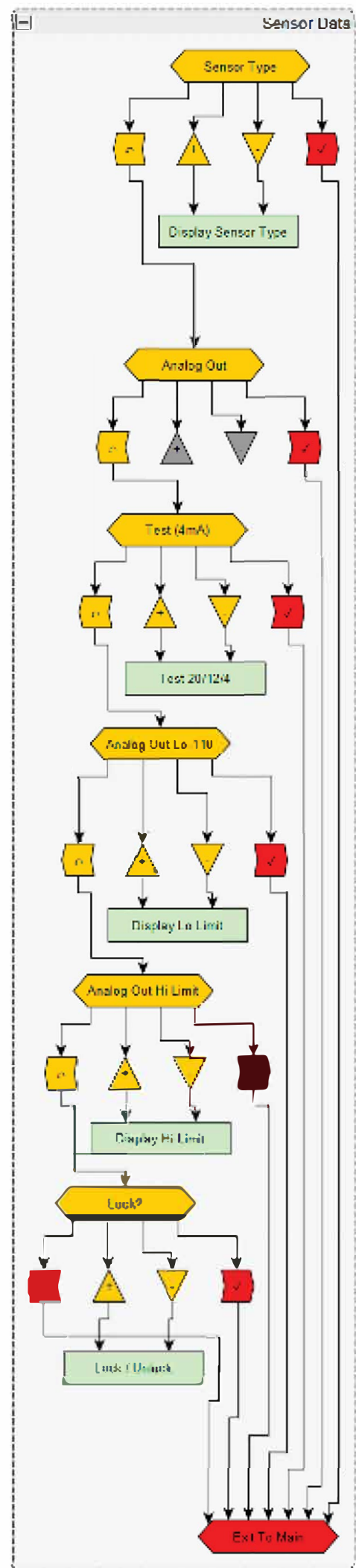
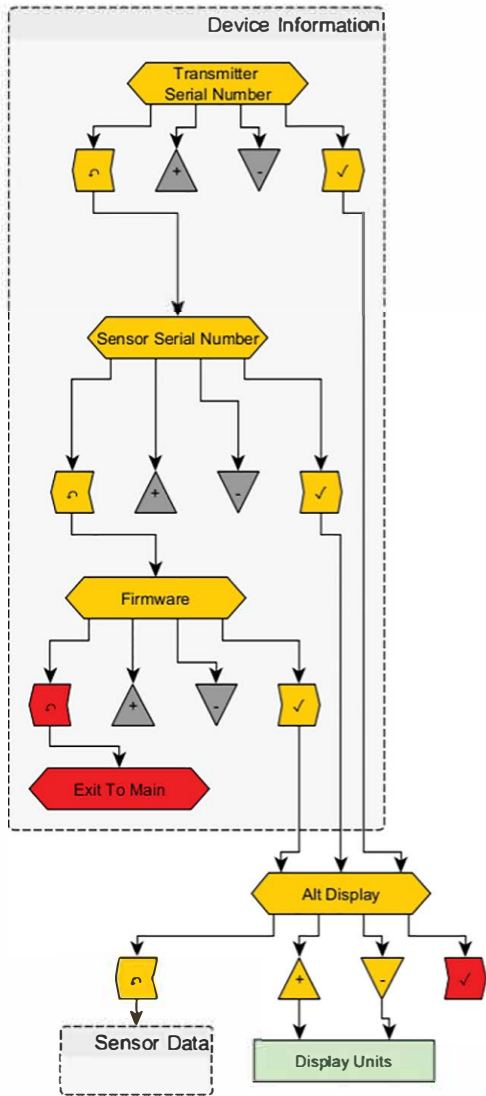

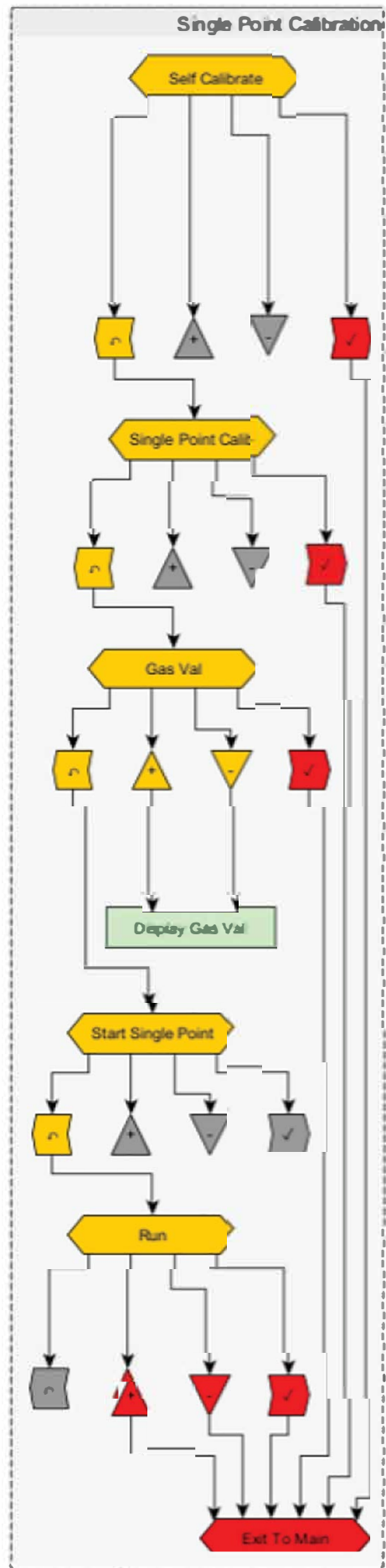
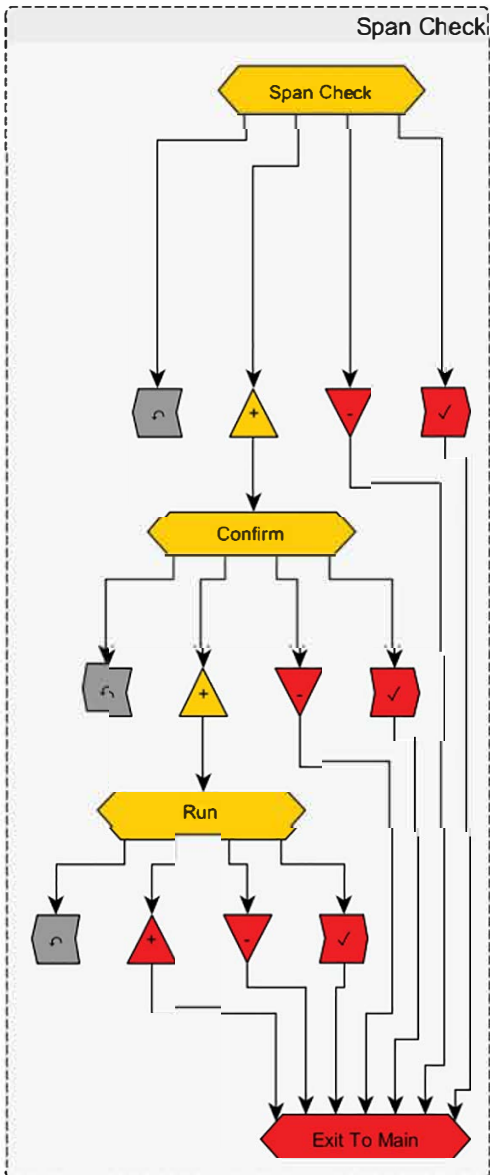

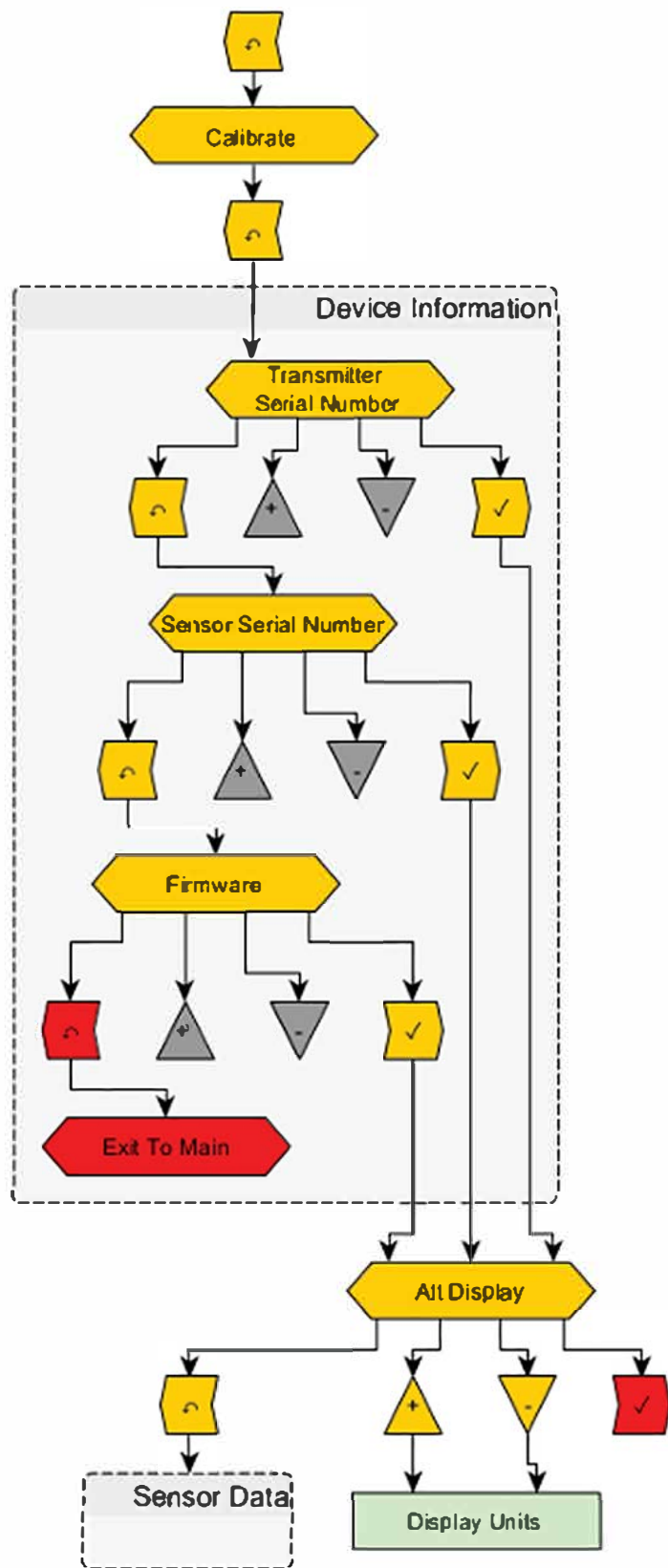

Appendix C: Setup State flowchart

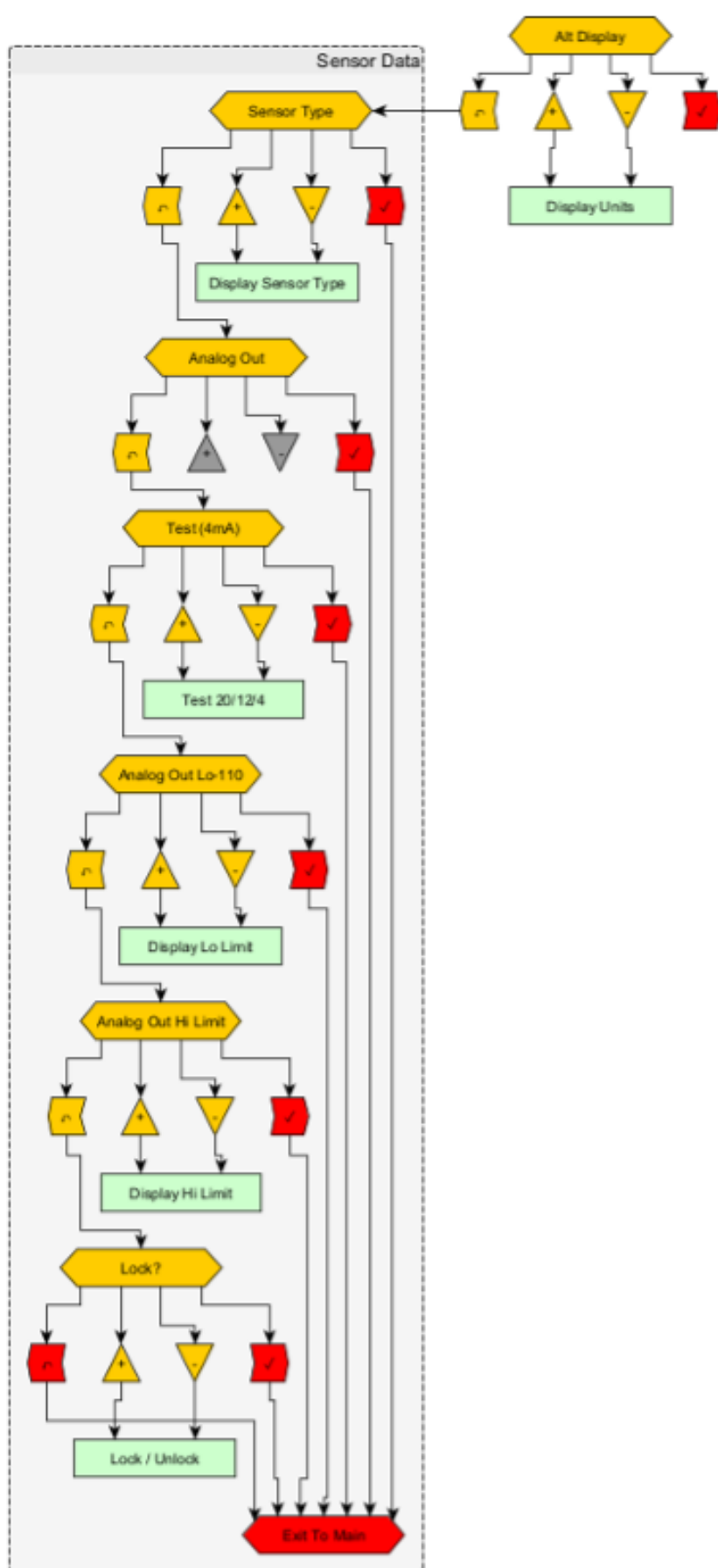

Appendix D: LPDT2 Mechanical Drawing

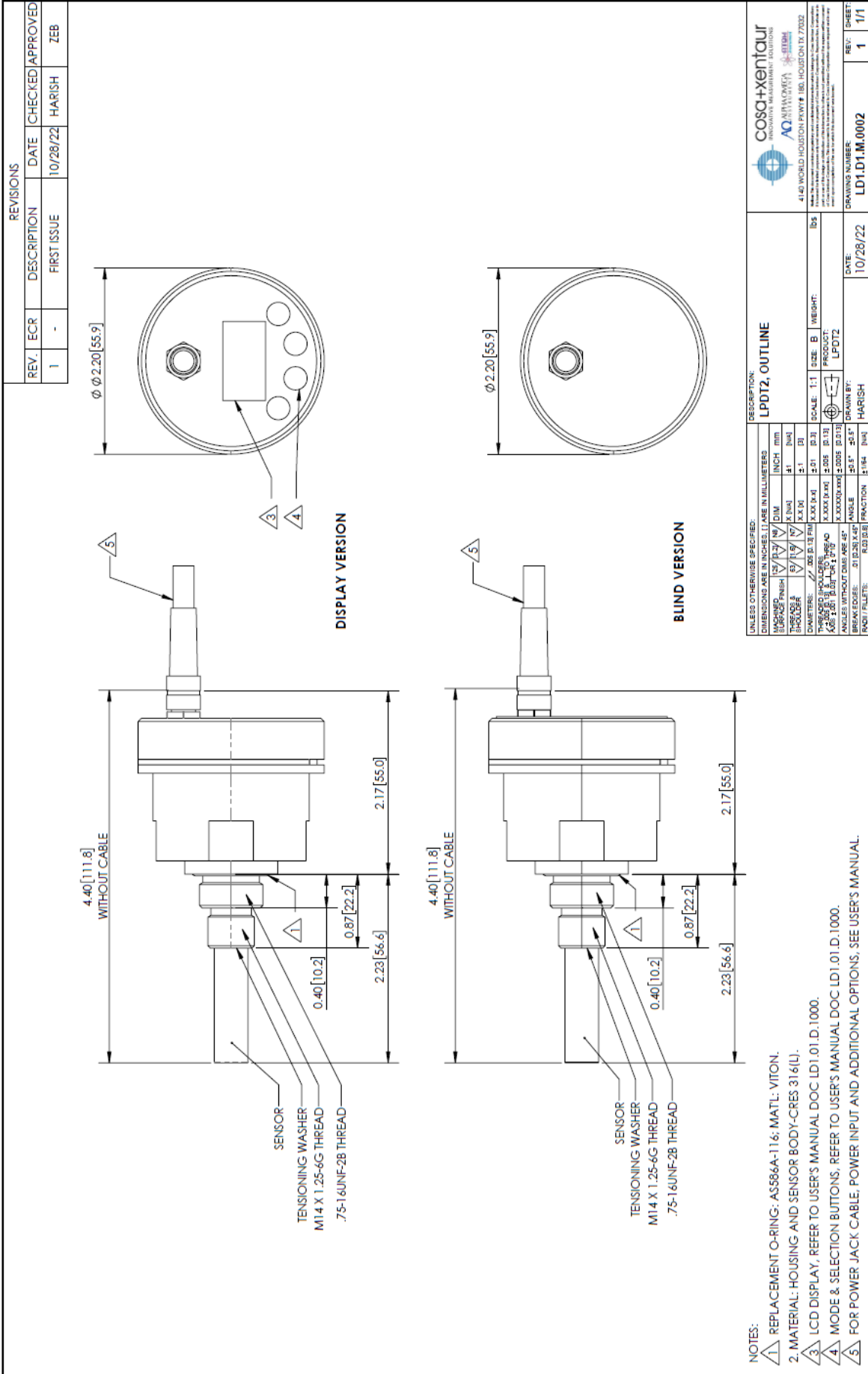

Appendix E: LPDT2 Electrical Connections

Methods of Using and Interfacing the LPDT2

Operation with DC power supply, Dew point viewed on display and available as 4-20mA

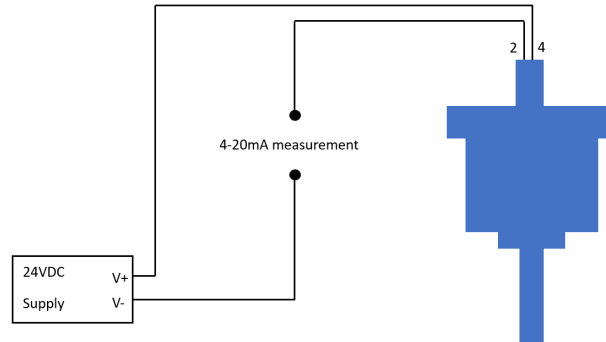

Operation with power supply and modbus (over RS-485)

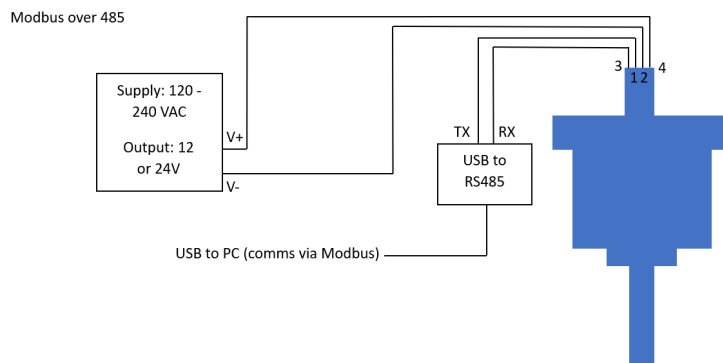

LPDT2 Mating Connector layout

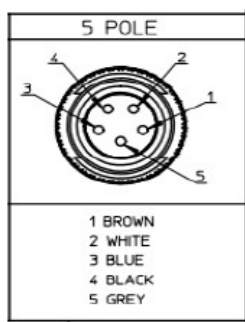

LPDT2 Mating Connector



Pin #	Wire color SD-120086-102	Description
Pin1	Brown	RS-485-A
Pin2	White	Power (10-33V not polarity sensitive) /4-20mA input
Pin3	Blue	RS-485-B
Pin4	Black	Power (10-33V not polarity sensitive) /4-20mA input
Pin5	Gray	Ground

Appendix F: Current vs. Dew Point

The current being pulled by the LPDT, varies with the dew point being measured by the LPDT2. To use the current to calculate the value of the dew point measurement, one must know the settings of the low and high ends of the analog output range, then:

$$D = \frac{(I - 4) \times (H - L)}{16} + L$$

where: I = current drawn by LPDT2 loop in mA.

H = value of High end of Analog Output range converted to selected engineering units

L = value of Low end of Analog Output range converted to selected engineering units

D = dew point measured by instrument in selected engineering units.

Consult section 3.4.5.7&8 and/or appendix B, to check and set the Analog Output low and high ranges; the factory default settings are -100°C and +20°C respectively.

For example a unit with factory default settings, drawing 12mA is computed to be measuring a dew point of -40°C:

$$\frac{(12 - 4) \times (20 - (-100))}{16} + (-100) = -40$$

Note that the computation is such that the current is linear to the selected engineering units. Hence, selecting ppmV or LBS or G/M3 units, will cause the analog output to be linearly proportional to those units (approximately logarithmically proportional to dew point), refer to the graph that follows. Naturally selecting °C or °F will cause the analog output to be linearly proportional to dew point.

When monitoring in ppmV or LBS or G/M3, the analog output low & high ranges may have to be adjusted to provide a useful output. Consider an example where the area of interest to be monitored is 10 to 100 ppmV, and the analog output is set up with the factory defaults of -100°C to +20°C (which is 0.014 to 23612 ppmV); then the current loop output will vary only from ~4.1 to ~4.2 mA in the area of interest (consult with the graph on the following page). In most instances this would be an unacceptable output for proper monitoring of the measurement. In this example the user should adjust the analog output low & high ranges such that the output range is better suited to the measurement of 10 to 100 ppmV. It may be useful to select the low and high ranges to be 5 and 150 ppmV respectively, thus out of range conditions will be detected properly. Then the low range will be set to 5ppmV which is -65.5°C dew point, and the high range will be set to 150ppmV which is -38.5°C dew- point. Now the current loop output will be 4.55 to 14.48 mA in the range of 10 to 100 ppmV, the ~10mA variation is more than sufficient for a good measurement by the user's equipment. One may carry out similar calculations for LBS or G/M3 and choose the appropriate settings.

If you are not certain how to carry out such calculations send email to service@Cosa-Xentaur.com your system specifics, and someone will get back to you with appropriate analog output settings.

In general, if the dew point is monitored in °C or °F, there is no need to change the factory default -100°C to +20°C settings, because the 4-20mA provides sufficient resolution to measure the output better than the specified accuracy of the sensor.

Relationship of 4-20mA output and instrument reading in ppmV or LBS

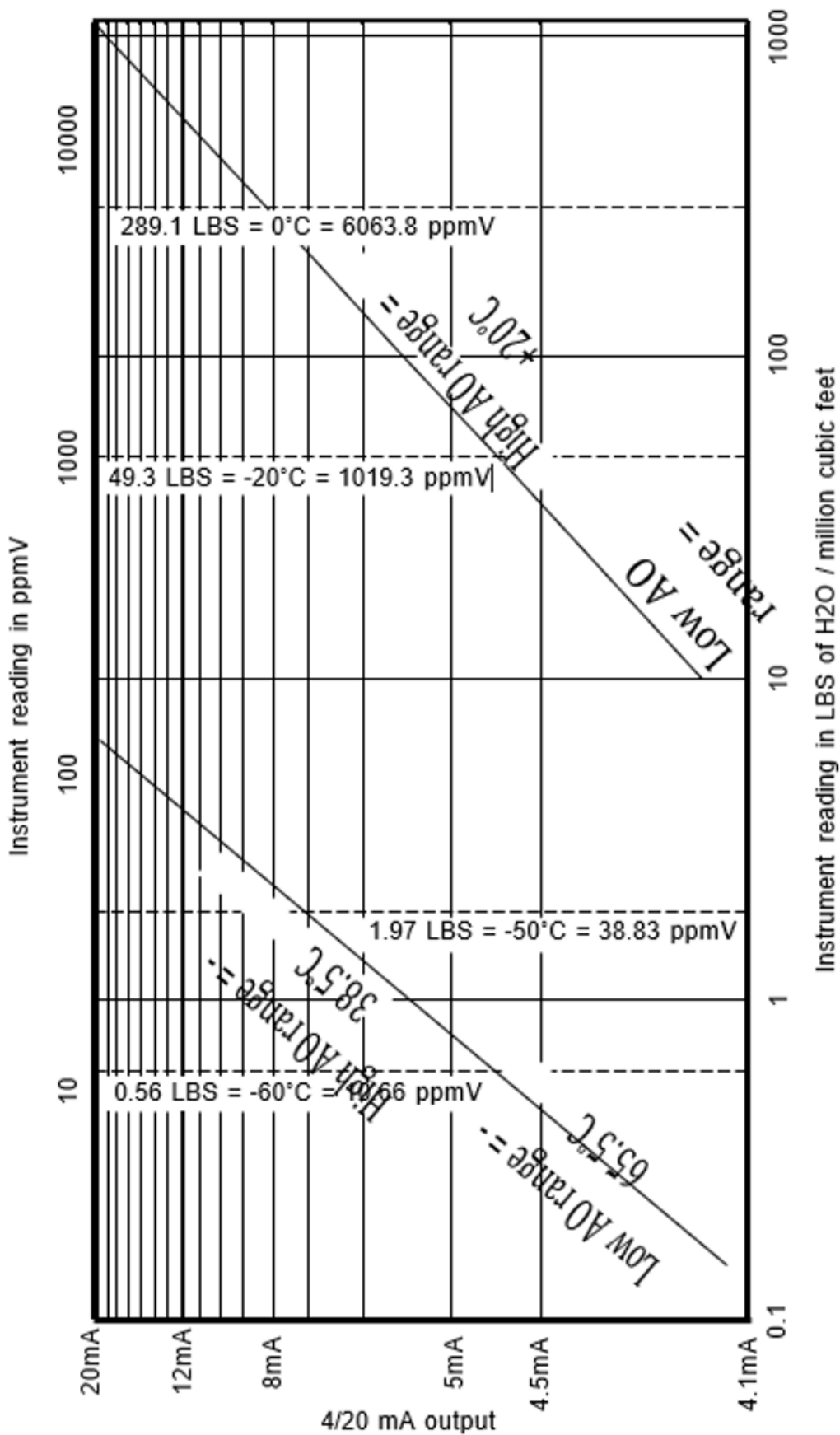

Appendix G: Uncertainty in LBS & ppmV calculations

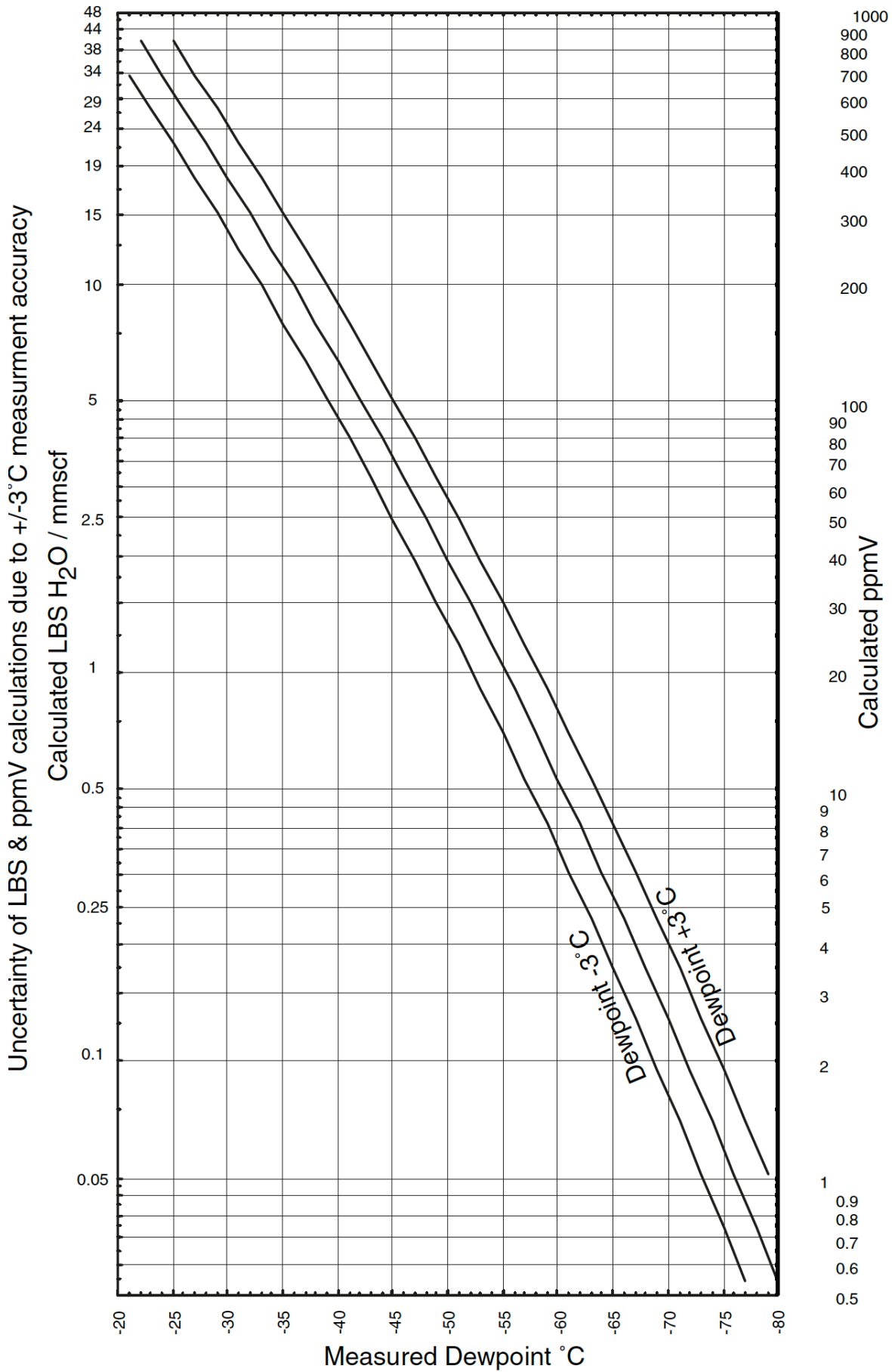

Appendix H: Sensor Response Time

Response Time of Cosa-Xentaur Al_2O_3 Sensors to a Step-change (DOWN) from $-39.4\text{ }^\circ\text{C}(\text{dp})$ at time 0, to $-62.2\text{ }^\circ\text{C}(\text{dp})$ after 48hrs of equilibrium

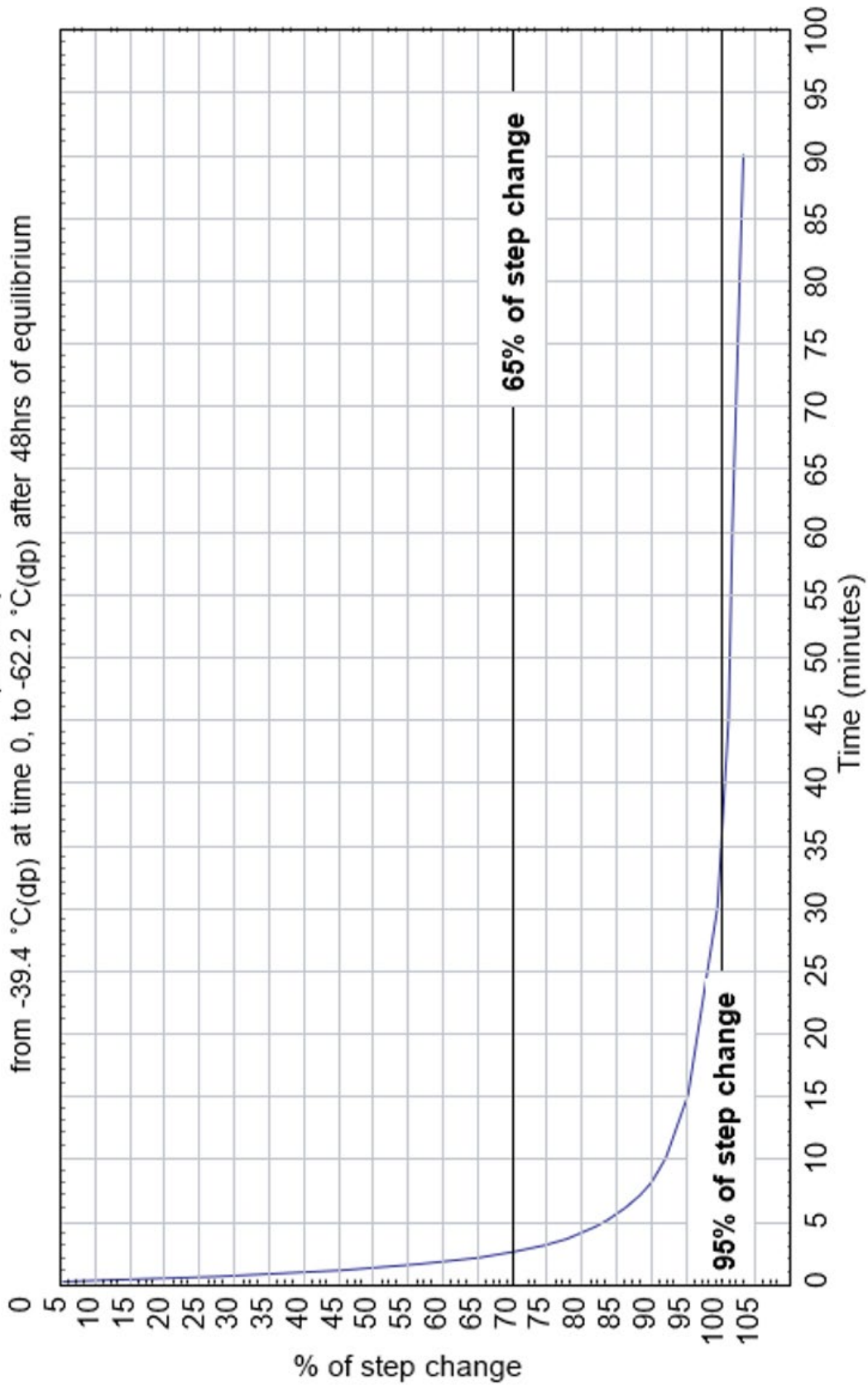



Certificate of Conformance

European Community Council Directive 2014/35/EU

Issue Date: 12 August 2022

COSA Xentaur Corporation hereby acknowledges that the Loop powered Dew Point Transmitter (LPDT2) product has been designed and is in conformity to the following standards:

EN 61010-1: 2010+A1:2019

The authorized signatory to this declaration, on behalf of the manufacturer is identified below:

Scott Fleishner
Group President, Industrial & Technical
Services Cosa Xentaur Corporation

Manufacturing Address:
84 Horseblock Rd, St G
Yaphank, NY 11980

COSA Xentaur, 4140 World Houston Parkway, Suite 180, Houston, TX 77032, USA
+1 713 947 9591

Appendix J: LPDT Modbus Format

LPDT Commands

The LPDT communicates over serial cable using the Modbus Protocol. The control program or host machine makes and sends a request to the LPDT, which then acts accordingly and responds with a message that depends on the request. The default baud rate is set to 19200 and slave ID is set to 2. All Modbus messages over serial are variable length strings of 8-bit hexadecimal data.

This is the standard format for a Modbus message, be it request or response:

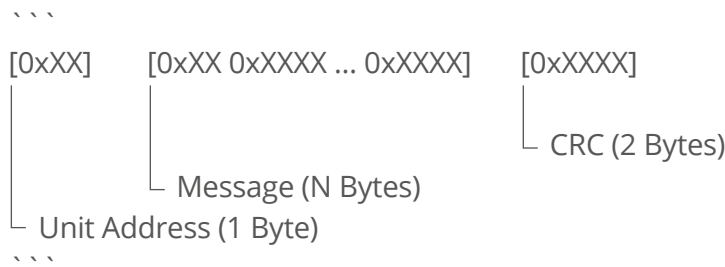

Where:

- The **Unit Address** is the device's address over serial encoded as one Byte.
- The **Message** is a *Modbus PDU (protocol data unit)*.
- The **CRC** is a cyclic redundancy check of the **Unit Address** and **Message** fields.
- The maximum length of the entire message is 256 Bytes.

There are 3 *Modbus PDUs* that are relevant to the LPDT. These are the **Modbus Read Holding Registers (03)**, **Modbus Read Input Registers (04)**, and **Modbus Write Multiple Registers (16)** protocols.

The PDU format of these protocols are as follows:

Modbus Read Holding Registers (03)

Request:

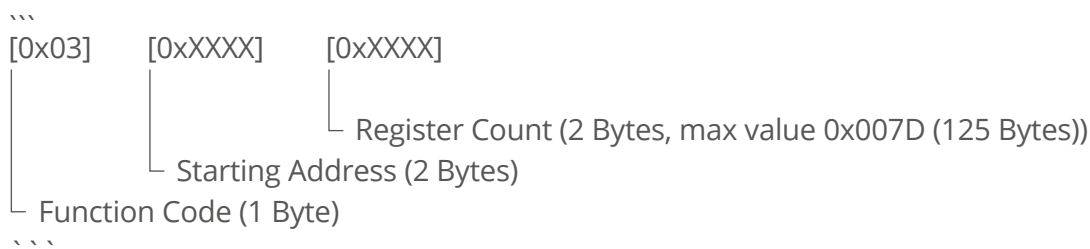

Response:

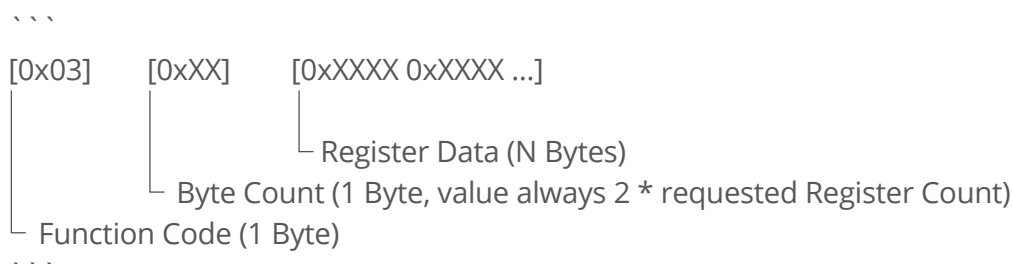

Modbus Read Input Registers (04)

Request:

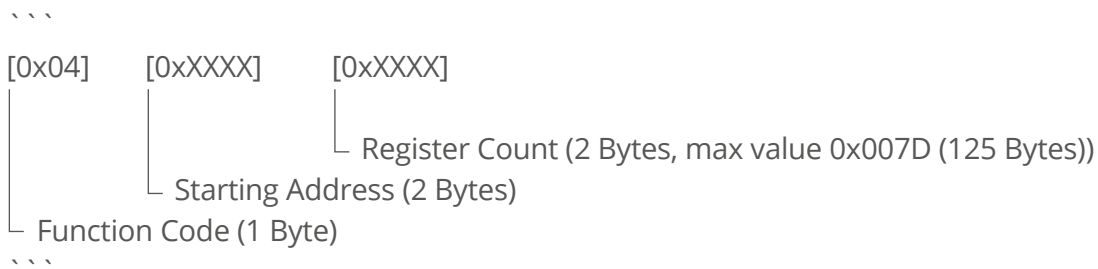

Response:

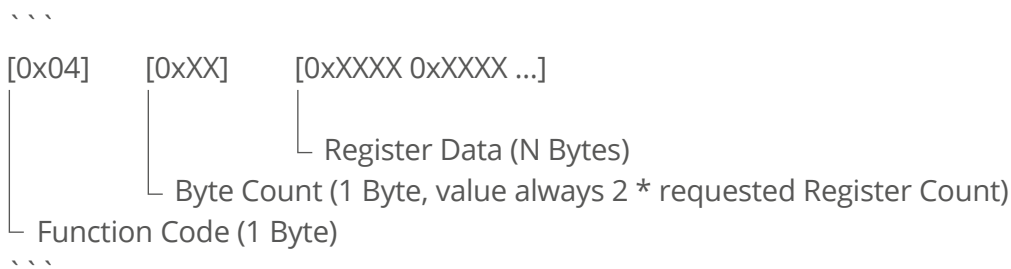

Modbus Write Multiple Registers (16)

Request:

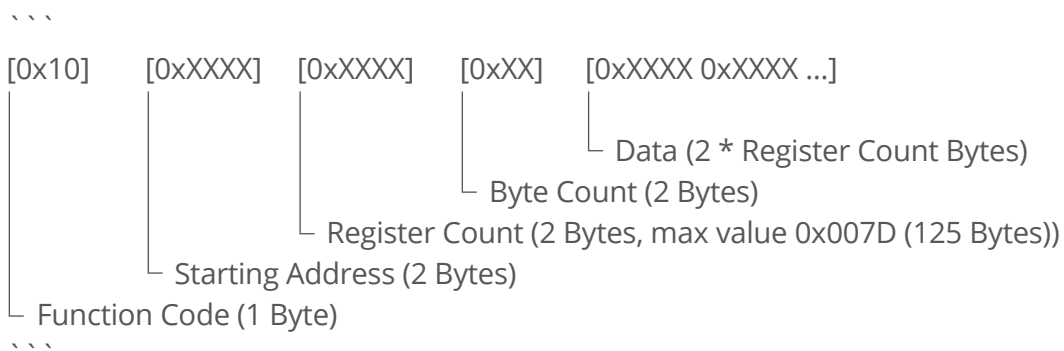

Response:

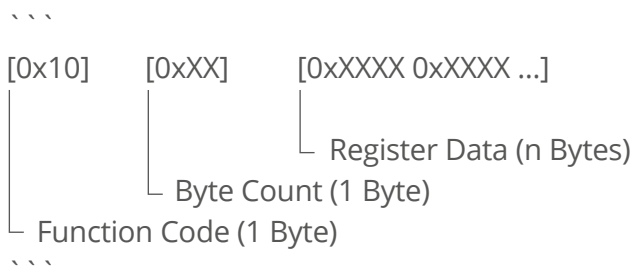

Address	Description	Size	Possible Range	Inferred Type	Function Codes
0*	Dew Point (Read Only)	2r	-100.00 to 20.00	Float	Read (04)
1010	Model Number	1r	0x0000	UInt	Read (03)
1011	Serial Number	2r	0x00000000 Factory Assigned	UInt	Read (03)
1013	Software Revision	2r	0x0000001e Factory Assigned	UInt	Read (03)
1101	Sensor SN	2r	0x00000000 Factory Assigned	UInt	Read (03)
1115	Dew Point Offset	2r	-100 to 100	Float	Read (03) Write (16)
407	Dew Point Loop High Limit	2r	-100.00 to 20.00	Float	
405	Dew Point Loop Low Limit	2r	-100.00 to 20.00	Float	
402	DAC High Bound (Zero 20mA)	1r	1000 to 65000	UInt	
401	DAC Low Bound (Zero 4mA)	1r	1000 to 65535	UInt	

PREMIUM INSIGHTS – GAIN REAL-TIME INSIGHT INTO YOUR PROCESS

Process Insights' products and solutions deliver innovative and differentiated analysis and measurement solutions and technologies that add high value to our customers and protect the environment.

Our commitment is to deliver smart and affordable innovation that optimizes process, improves safety, and transforms our world.

CENTERS OF EXCELLENCE

PROVIDING PROVEN SOLUTIONS FROM A GLOBAL TECHNOLOGY LEADER

Process Insights – The Americas

4140 World Houston Parkway, Suite 180, Houston, TX 77032, USA
+1 713 947 9591
info@process-insights.com

Process Insights – EMEA

ATRICOM, Lyoner Strasse 15, 60528 Frankfurt, Germany
+49 69 20436910
info@process-insights.com

Process Insights – APAC

Wujiang Economic and Technology, Development Zone, No. 258 Yi He Road, 215200 Suzhou Jiangsu Province China
+86 400 086 0106
info@process-insights.com

OUR PREMIUM GLOBAL BRANDS

